



Temperature Concentrator System™
Multi-Channel Transmitter

TCS

User's Manual

All product names are registered trademarks of their respective companies.

Table of Contents

Introduction	5
About this Manual	5
Model and Serial Numbers.....	5
The TCS	5
HART Communications Mode	5
MODBUS RTU Communications Mode	6
TCM Specifications	8
TCM Dimensions.....	10
TCM Terminal Designations	10
Connecting the TCM in HART Mode	11
Temperature Concentrator Module	12
Configuring the TCM	12
Installing the Configuration Software	13
Using a Hand-Held Communicator	13
Necessary Equipment Table for the TCM.....	13
TCM PC Configuration Software Summary	14
Menu and Tool Bar Legend	15
Configuration Screens.....	16
Additional Features	19
Using the HART Communicator	20
Programming when a Device Description is Available	20
The HART Communicator Menu Without a Device Description	22
HART Status Information	26

HART-to-MODBUS Converter	28
Installing the HMC Configuration Software	28
Connecting the HMC to the PC.....	28
HMC Specifications	29
HMC Dimensions	30
HMC Terminal Designations.....	30
Necessary Equipment Table for the HMC	31
HMC PC Configuration Software Summary	32
Menu and Tool Bar Legend	33
Configuration Screens.....	33
MODBUS RTU Registers	35
Installation.....	36
Mounting the TCM and HMC.....	36
Making the Electrical Connections	36
Recommended Ground Wiring Practices	36
Supply Wiring	36
CE Conformity.....	36
Operation.....	37
HART Protocol	37
Maintenance.....	37
Customer Support.....	37

Installation in Hazardous Locations	38
Specific conditions of Use.....	38
IECEx Installation	41
Appendix A:TCS/Stahl I.S. Barrier Configuration.....	43
Appendix B:TCS/GMI I.S. Barrier Configuration.....	44

Introduction

This manual for Moore Industries' TCS Temperature Concentrator System™ contains all of the information needed to configure, install, operate and maintain this product.

About this Manual

Pay particular attention wherever you see a "**Note**", "**Caution**" or "**WARNING**".

Note– Information that is helpful for a procedure, condition or operation of the unit.

Caution– Hazardous procedure or condition that could damage or destroy the unit.

WARNING– Hazardous procedure or condition that could injure the operator.

Model and Serial Numbers

Moore Industries uses the model and serial numbers of our instruments to track information regarding each unit that we sell and service. If a problem occurs with your instrument, check for a tag affixed to the unit listing these numbers. Supply the Customer Support representative with this information when calling.

To obtain the TCM's serial number, you may read it from the label. You may also use any device that can read the TCM's Device Description (i.e. portable DD shell) or use the TCM Intelligent PC Configuration Software program.

The TCS System Architecture

A TCS Temperature Concentrator System may consist of one or two (when used with an HMC HART-to-MODBUS Converter) 16-channel, loop-powered (2-wire) TCM Temperature Concentrator Modules; an optional 4-wire (line/mains-powered) HMC HART-to-MODBUS Converter; and, for intrinsically-safe applications, an optional I.S. barrier.

Each of the TCM Temperature Concentrator Module's 16 channels can be individually configured to accept an RTD, T/C, millivolt and/or resistance/potentiometer signal. When two TCM modules are used in a Temperature Concentrator System, up to 32 signals can be monitored over one twisted wire pair.

The TCM converts the signal inputs to the standard HART digital communications protocol and transmits the data long distances from the field to the control room on one economical digital data link.

Figure 1. TCS in general purpose or Class I, Division 2 or Zone 2 HART Communications Mode (accommodates one TCM per system).

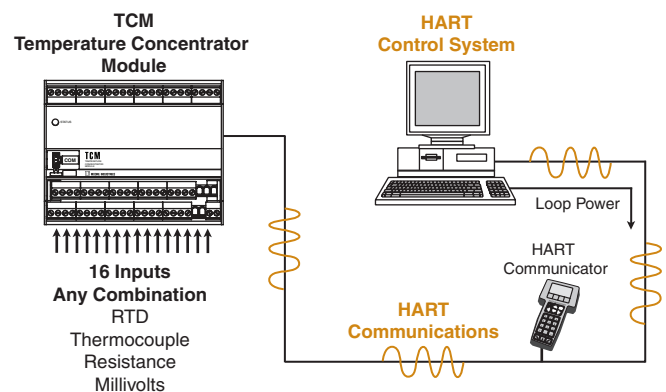

HART Communications (HART Mode)

When used in the HART Communications Mode, one TCM Temperature Concentrator Module may be used within a system. The TCM communicates via the HART digital communications protocol, allowing direct interface with HART-based systems, such as an AMS. When communicating to a HART DCS, each of the TCM's 16 channels is assigned a unique HART address and set to act as a distinct HART slave device in a HART multi-drop network.

TCS

Temperature Concentrator System™
Multi-Channel Transmitter

All TCM operating parameters (with the exception of custom input linearization) can be configured from the HART-based system, or using a standard HART hand-held, from anywhere along the twisted wire pair. The TCM can also be configured, including custom input linearization, using Moore Industries' Intelligent PC Configuration Software.

If the HMC is specified for the application, the TCM can still be configured from any termination point along the twisted wire pair, beyond the input side of the HMC, using a HART hand-held.

The HMC is configured using Moore Industries' HMC Intelligent PC Configuration Software.

Figure 2. TCS in Intrinsically-Safe HART Communications Mode (accommodates one TCM per system).

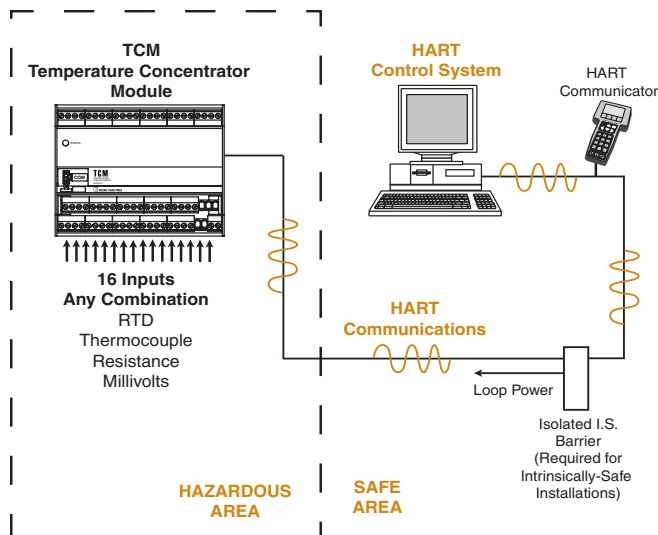
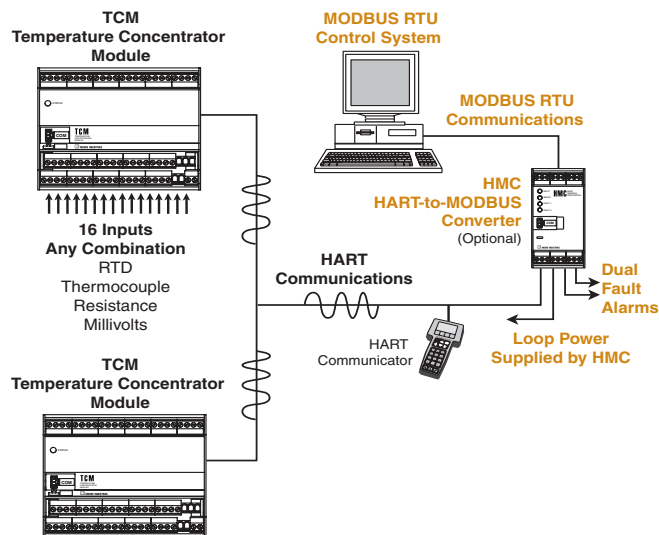

Figure 3. TCS in MODBUS RTU Communications Mode.



MODBUS RTU Communications (TCS Mode)

Using the TCS in a MODBUS RTU-based host system requires the use of a HART-to-MODBUS Converter (HMC). This can monitor up to 32 inputs on two TCM units (16 inputs per unit).

HMC HART-to-MODBUS Converter—Acting as the HART Primary Master, the HMC issues HART commands instructing the TCM to transmit all of its data in a single poll.

The HMC converts the TCM's HART digital data to a serial MODBUS RTU (RS-485) communications protocol to allow direct connection with MODBUS-based monitoring and control systems (such as a PLC or DCS). The HMC offers dual MODBUS communication ports so redundant communications can take place with one or more MODBUS RTU hosts.

Figure 4. TCS in Intrinsically-Safe MODBUS RTU Communications Mode.

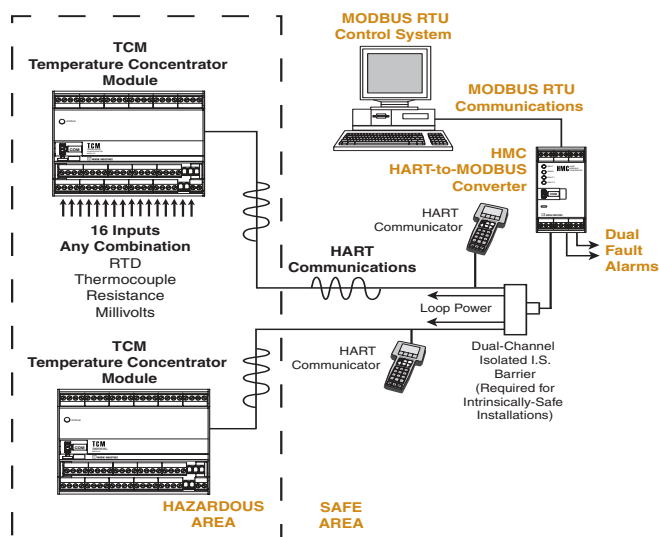
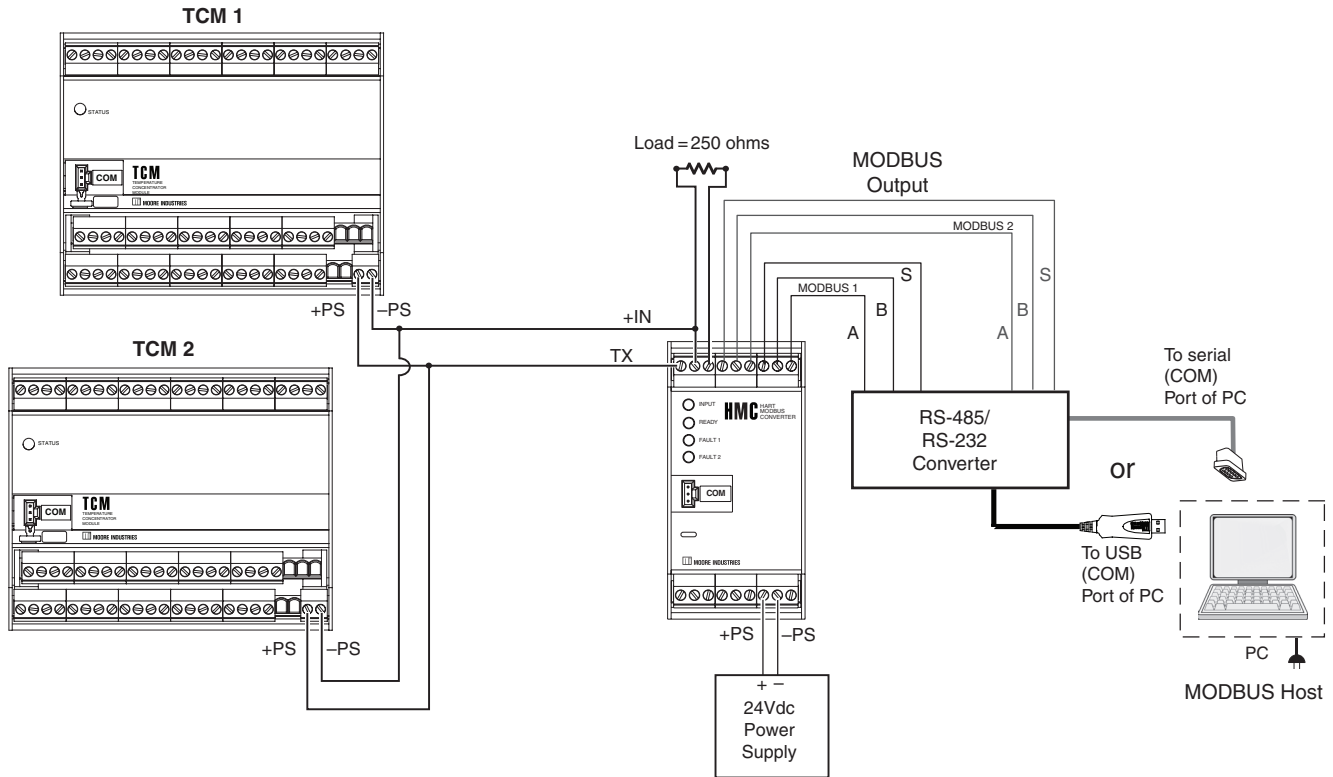

Figure 5. TCS System Hook-Up Using TX Power



TCS

Temperature Concentrator System™
Multi-Channel Transmitter

TCM Specifications

<p>HART Specifications Address Range: 0-15 (in HART Communications Mode) Transmission Speed: 1200bps Character Format: 1 Start Bit - 8 Data Bits - 1 Odd Parity Bit - 1 Stop Bit</p> <p>Performance Input Accuracy: Refer to Table 4 Overall Accuracy: The overall accuracy of the unit is the input accuracy. It includes the combined effects of linearity, hysteresis, repeatability and adjustment resolution. It does not include ambient temperature effect. For T/C input, add the Reference Junction Compensation error Reference (Cold) Junction Compensation: ±0.65°C (±1.17°F) Stability: Refer to Table 2 Isolation: 500Vrms between inputs and output (no isolation between individual input channels) Input Overload Protection: ±5Vdc, maximum</p>	<p>Performance (continued) Digital Input Filter: 50/60 Hz, User-configurable Power Supply Requirements: 15-42Vdc for Standard version, 15-30Vdc for Intrinsically Safe version, 15mA maximum, 12.5mA typical Input Impedance: T/C and mV: 40Mohms, nominal RTD and Ohms Excitation: 210microamps, ±10% RTD Lead Wire Resistance Maximum: RTD resistance + 2X lead wire resistance: < 4000 ohms max; Recommended lead wire resistance for 3-wire connections: <35 ohms/wire; 10 ohm copper sensor <5 ohms</p> <p>Indicators LED Type: STATUS LED: Red indicates Power On, Not-Initialized; Green indicates Power On, System OK; Green/Amber (flashing): Power On, Communication detected Red/Green (flashing): Power On, Error</p>	<p>Indicators Operating and Storage Range: -40°C to +85°C (-40°F to +185°F) Relative Humidity: 0-95%, non-condensing Ambient Temperature Effect: Refer to Table 4 Startup Time: <0.5sec, maximum Loss of Input: HART status byte indicates faults Noise Rejection: Common mode, 100dB@50/60Hz; Normal Mode: Refer to Table 3 RFI/EMI Immunity: 10V/m@80-1000MHz, 1kHz AM, when tested according to IEC61326</p> <p>Weight 749g (1.7 lbs)</p> <div style="border: 1px solid black; padding: 5px;"> <p>I.S. Entity Parameters (Power/Loop, +PS & -PS):</p> <p>Vmax or Ui = 30Vdc Imax or li = 110mA Pmax or Pi = 0.825W Ci = 0F Li = 0H</p> <p>Sensor Outputs (Combined Total)</p> <p>Ca or Co = 396µF La or Lo = 9.4µH Voc or Vt = 4.0Vdc Isc or It = 254.14mA Po = 0.71738W</p> </div>
--	--	--

Specifications and information subject to change without notice.

Table 1. Long-Term Stability

Stability (% of maximum span)	Input-to-HART (Years)		
	1	3	5
RTD, Ohm & Pot Inputs	0.047	0.081	0.104
T/C & mV Inputs	0.08	0.14	0.18

Table 2. Normal Mode Rejection Ratio Table

Sensor Type	Max. p-p Voltage Injection for 60dB at 50/60Hz	
T/C: J, K, N, C, E	125mV	
T/C: T, R, S, B	80mV	
Pt RTD: 100, 200, 300 ohms	250mV	
Pt RTD: 400, 500, 1000 ohms	500mV	
Ni: 120 ohms	500mV	
Resistance	mV	
1-4kohms	250-1000	500mV
0.25-1kohms	62.5-250	200mV
0.125-0.25kohms	31.25-62.5	100mV

Table 3. Ambient Temperature Effect

Input Type	Accuracy per 1°C (1.8°F) change in Ambient
*RTD	0.0035°C
Millivolt	0.5 microvolts + 0.005% of reading
Ohm	0.002 ohms + 0.005% of reading
Thermocouples	
Input Type	Accuracy per 1°C (1.8°F) change in Ambient
J	0.00016°C + 0.005% of reading
K	0.0002°C + 0.005% of reading
E	0.00026°C + 0.005% of reading
T	0.0001°C + 0.005% of reading
R, S	0.00075°C + 0.005% of reading
B	0.0038°C + 0.005% of reading
N	0.0003°C + 0.005% of reading
C	0.00043°C + 0.005% of reading

*Accuracy of Ni672 is 0.002°C

Table 4. TCM Input and Accuracy Table

Input	Type	α	Ohms	Conformance Range	Minimum Span	Input Accuracy	Maximum Range
RTD	Platinum	0.003850	100	-200 to 850°C -328 to 1562°F	10°C (18°F)	±0.5°C ±0.9°F	-240 to 960°C -400 to 1760°F
			200				
			300				
			400				
			500				
			1000				
	Platinum	0.003902	100	-100 to 650°C -148 to 1202°F		±0.5°C ±0.9°F	-150 to 720°C -238 to 1328°F
			200				
			400				
			500				
Platinum	0.003916	100	-200 to 510°C -328 to 950°F	±0.5°C ±0.9°F	-240 to 580°C -400 to 1076°F		
		Nickel	0.00672		120	-80 to 320°C -112 to 608°F	±0.5°C ±0.9°F
Copper	0.00427	9.035	-50 to 250°C -58 to 482°F	±1.5°C ±2.7°F	-65 to 280°C -85 to 536°F		
Ohms	Direct Resistance	n/a	0-4000 ohms	0-4000 ohms	10 ohms	±2 ohms	0-4095 ohms
	Potentiometer		125, 250, 500, 1k, 2k, 4k ohms	0-100%	10%	±0.5%	0-100%
T/C	J	n/a	n/a	-180 to 760°C -292 to 1400°F	35°C 63°F	±0.5°C ±0.9°F	-210 to 770°C -346 to 1418°F
	K	n/a	n/a	-150 to 1370°C -238 to 2498°F	40°C 72°F	±0.75°C ±1.35°F	-270 to 1390°C -454 to 2534°F
	E	n/a	n/a	-170 to 1000°C -274 to 1832°F	35°C 63°F	±0.5°C ±0.9°F	-270 to 1013°C -454 to 1855.4°F
	T	n/a	n/a	-170 to 400°C -274 to 752°F	35°C 63°F	±0.5°C ±0.9°F	-270 to 407°C -454 to 764.6°F
	R	n/a	n/a	0 to 1760°C 32 to 3200°F	50°C 90°F	±0.85°C ±1.53°F	-50 to 1786°C -58 to 3246.8°F
	S	n/a	n/a	0 to 1760°C 32 to 3200°F	50°C 90°F	±0.85°C ±1.53°F	-50 to 1786°C -58 to 3246.8°F
	B	n/a	n/a	400 to 1820°C 752 to 3308°F	75°C 135°F	±1.0°C ±1.8°F	200 to 1836°C 392 to 3336.8°F
	N	n/a	n/a	-130 to 1300°C -202 to 2372°F	45°C 81°F	±1.0°C ±1.8°F	-270 to 1316°C -454 to 2400.8°F
	C	n/a	n/a	0 to 2300°C 32 to 4172°F	100°C 180°F	±1.25°C ±2.25°F	0 to 2338°C 32 to 4240.4°F
Millivolts	DC	n/a	n/a	-1000 to 1000mV	4mV	150 microvolts	-1000 to 1000mV

TCS

Temperature Concentrator System™
Multi-Channel Transmitter

Figure 6. TCM Dimensions

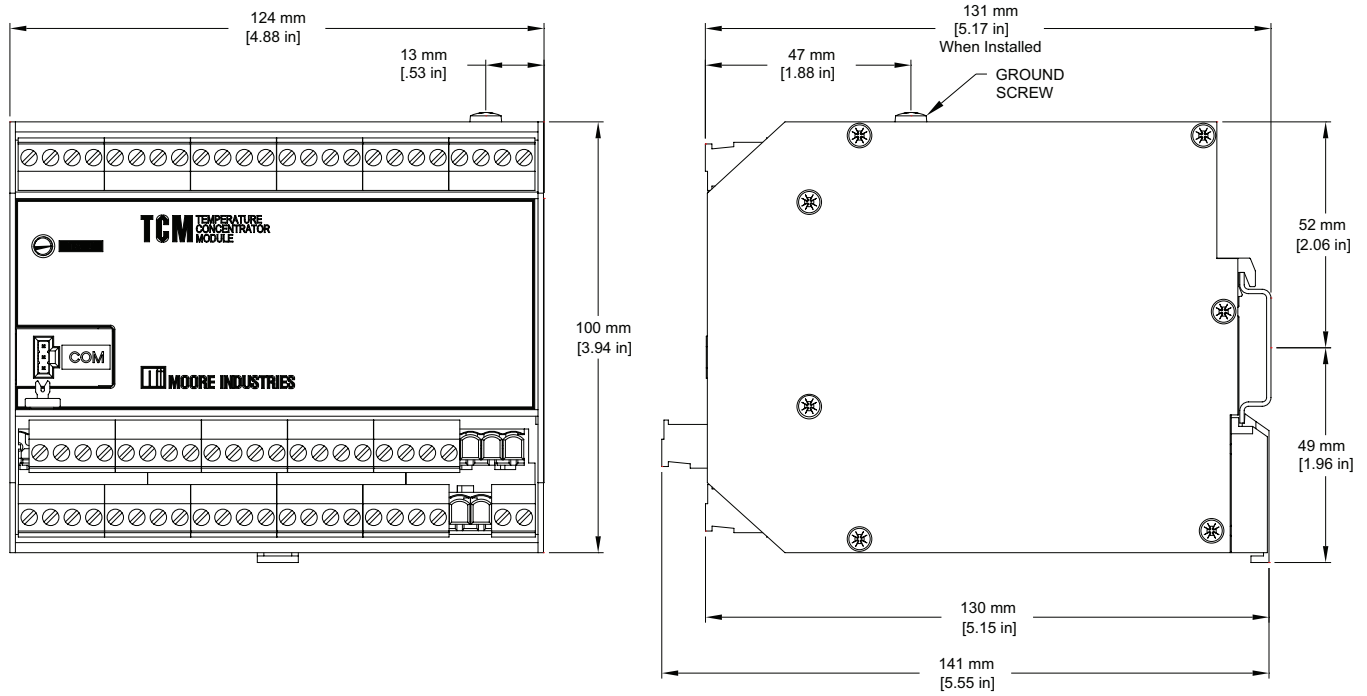

Figure 7. TCM Terminal Designations

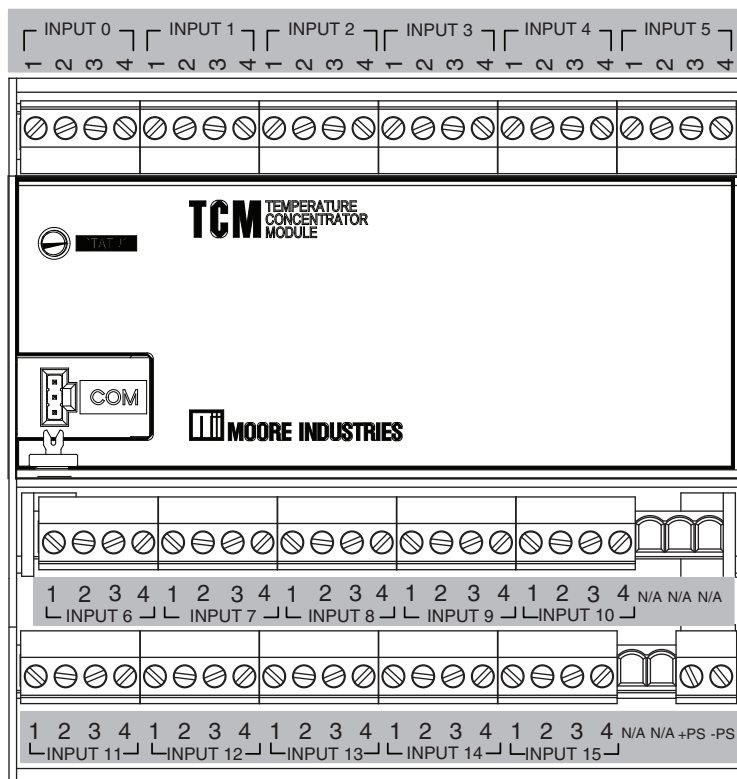
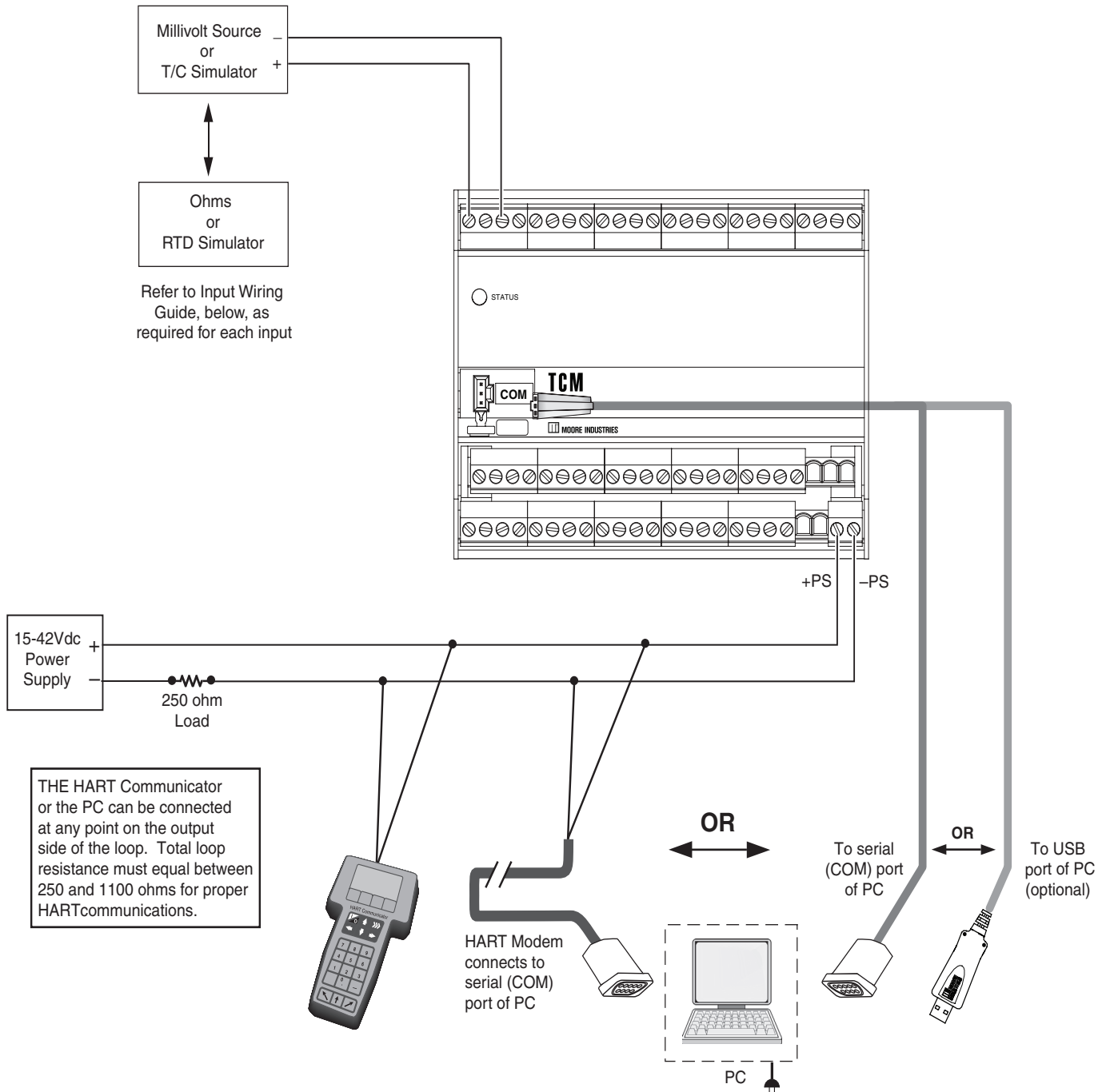
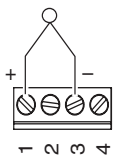

Figure 8. Connecting the TCM in HART Mode



Input Wiring Guide

Thermocouple and Millivolt Input



2-Wire RTD or Decade Resistance Box

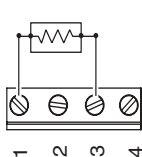

3-Wire RTD or Decade Resistance Box

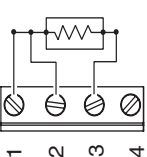

4-Wire RTD or Decade Resistance Box

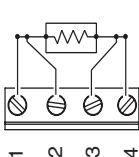

Potentiometer Input

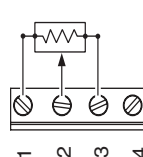

Temperature Concentrator Module

The following section describes use and configuration of the Temperature Concentrator Module (TCM).

The TCM may be used in one of two modes. A stand-alone Temperature Concentrator Module if it is configured in *HART* mode. In *HART* mode, the TCM is seen as 16 individual temperature devices each with its own address (0-15). In TCS Mode, one or two TCM's can be used on the same network to allow up to 32 signals to be transmitted to a MODBUS RTU Control System. (see Figures 3 and 4)

The TCM may be configured using a hand-held communicator or using Moore Industries' PC Configuration software using your PC's serial RS-232 port or optional USB cable.

The TCM is designed to require low operating power thus enabling it for use in Intrinsically-Safe applications. The addition of an I.S. barrier allows the instrument to operate in a hazardous area (refer to Figure 23 for I.S installation).

Configuring the TCM

All operating parameters are set using either a HART Communicator or a PC and Moore Industries' Intelligent PC Configuration software.

Configuration parameters are stored in the instrument's memory and can be saved on your PC hard drive or external media. The transmitter communicates with the PC through an RS-232 port or optional USB cable. A HART modem connection to the PC's serial port may also be used.

Table 5 and Figure 8 provide information needed to configure the unit.

Using a PC

If using a PC to configure your unit, first install the software as described on the next page, then setup the hardware as shown in Figure 8.

Installing the Configuration Software

Refer to Table 5 for the equipment needed.

1. Insert the *Moore Industries Interface Solution PC Configuration Software* CD into the CD drive of the PC. Access the CD and open the *TCM PC Configuration Software* folder.
2. Double-click the installation program located in the folder. Follow the prompts to correctly install the program.

Once the Configuration Program is installed on the PC, the TCM can be connected to equipment to simulate input and monitor output. You can then change the transmitter's operating parameters.

It is not necessary to connect the transmitter to a PC to create configuration files using the PC Configuration Program. The program can be run without connecting a transmitter, and *most* parameters can be set without benefit of input from a sensor or transmitter.

This makes it easy to create a set of operating parameters, save them to external media, and download them to one or more transmitters at a later time.

The TCM *must* be connected to the PC in order to receive configuration parameters (via download) and save configuration parameters from the transmitter's memory.

Connecting the TCM to the PC

To connect the TCM to the PC, you must establish a simple current loop for the transmitter by connecting a 15-42Vdc power supply, a 250 ohm resistor and the transmitter in series. See Table 1 for information on the necessary equipment. Refer to Figure 8 for installation.

Connect your instrument to the PC via the RS-232 serial port using the Moore Industries Interface Cable or optional USB cable listed in Table 1.

Using a Hand-Held Communicator

A HART modem may also be used to connect your unit to the PC. Connect the RS-232 or optional USB cable end of the modem to the PC's COM port, then connect the HART output end of the modem (two hook-up wires) across the transmitter or the load resistor. For installation, refer to Figure 8.

Table 5. Necessary Equipment Table for the TCM

Device	Specifications
Variable Input Simulator for Thermocouple, RTD, Millivolt, Potentiometer, or Decade Resistance Box	Variable; Accurate to $\pm 0.05\%$ of unit span
Power Supply	15-42Vdc
Precision Load Resistor	250 ohms, $\pm 0.01\%$
Multimeter (optional)	Accurate to $\pm 0.025\%$ of span; e.g., Fluke Model 87
Personal Computer (Required only if using a PC for setup)	Pentium-based PC, or equivalent with: CD Drive; 4Mb free RAM (8Mb recommended); 20Mb free disk space on hard drive Operating System: Microsoft Windows® XP, Vista 7 or 10, one serial port 1 (one) serial or USB port
Moore Industries Communications Cable	Part# 803-040-26 (for a 9-pin serial port) or 804-030-26 (for a USB port).
HART Modem Cable (Required only if using a PC)	Moore Industries part number 803-048-26, or equivalent
Moore Industries PC Configuration Software (Required only if using a PC)	Version 1.0 or greater, successfully installed to the hard drive
HART Communicator (Required only if NOT using a PC)	HART compliant communicator capable of running necessary device description files

TCM PC Configuration Software Summary

Figure 9. TCM PC Configuration Software Main Screen

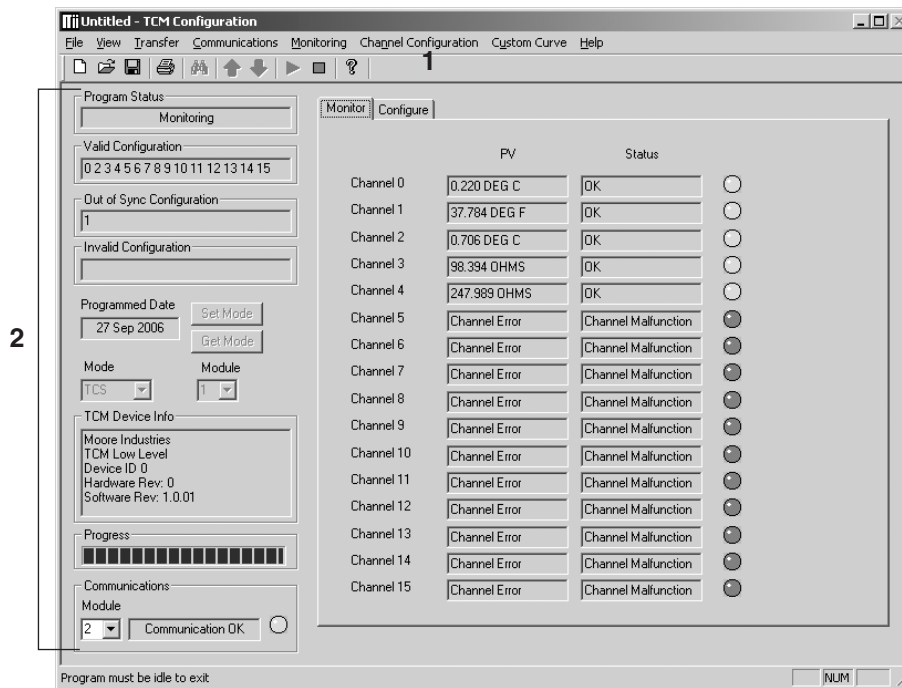

Note:

The Mode Setting* must be set before any configuration. This will insure that the correct MODE is active.

The PC Configuration Software program is made up of these sections:

- 1. Menu Bar/Tool Bar**– Dropdown menus and corresponding icons allow you to perform various functions throughout the PC Configuration Program. Refer to the *Menu and Tool Bar Legend* for a complete description.
- 2. Program Status**–This portion of the program displays the activity of the connected unit such: Idle, Monitoring, Uploading and Downloading.

Valid Configuration–This box displays all channels that are properly configured.

Out of Sync Configuration–This section will display any channel configurations which have not been downloaded to the TCM and therefore are out of sync with the instrument.

Invalid Configuration–This box displays all channels that are not configured properly and require correction.

Programmed Date– This is the date the instrument was last configured.

Mode*– This dropdown menu allows you to select *TCS* or *HART* mode. (mode must be selected prior to configuration)

In *TCS* mode, you are selecting to use the entire TCS system (TCM and HMC modules).

Using the *Module* box, select whether you are performing this configuration for Module 1 or 2.

HART mode allows you to use the TCM as a stand alone unit. In this mode, the TCM outputs a HART signal and your output is seen as 16 individual temperature devices each with its own address (addresses are configured automatically from 0-15).

Set Mode– Downloads the selected TCM mode to the TCM.

Get Mode– Uploads the configured TCM mode to the PC.

TCM Device Info– Indicates device identification.

Communications– Notifies user of current PC connection/communications status.

Monitor Tab

The first of two tabs in the main window of the TCM PC Configuration Software Program is the *Monitor* tab.

The *Monitor* tab displays the individual *PV* (Process Variable) and channel *Status* of each channel in use.

Configure Tab

Within the *Configure* tab, there are four sub-tabs (*Channel Info*, *Input*, *Scaling and Custom Curve*). These are explained in respective sections within this manual).

Consistent throughout the four tabs, however, are a *Channel* selection and *Channel Status* box.

Use the *Channel* box to select the channel that you want to configure.

The *Channel Status* box displays information regarding the selected channel.

The *Module* box (if configured in *TCS* mode), allows you to select, and indicates, which TCM Module, 1 or 2, is being monitored.

If in *HART* mode, The address displayed in the *Module* box reflects the *Channel* number displayed at the top of the *Configure* tab

Menu and Tool Bar Legend



Allows New/Open/Save File and Print functions



Controls whether Menu and Tool Bars are viewed on the screen as well as Channel error information



Allows you to Upload and Download configurations, perform a TCM Search and use Set or Get Mode functions



Allows selection of PC COM ports as well as Communication Method (Auto, RS232 or HART)

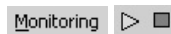

Allows you to Monitor and Stop monitoring the instrument



Allows channel selection, access to Import/Export Wizard and uploading/downloading of individual channels



Provides functions specific to your Custom Curve table



Displays the version of the PC Configuration Program and the Help file

TCS

Temperature Concentrator System™
Multi-Channel Transmitter

Configuration Screens

Note:

Unless otherwise noted, ensure that the PC Configuration Program is idle before making any selections or configuration changes to the program. Also, when attempting to download or upload, monitoring must be stopped. To do this, click Stop in the Monitoring dropdown menu, or click the Stop Monitoring icon on the Tool Bar.

Channel Info Tab

The Channel Info tab is mainly a read-only screen indicating status of the channel displayed.

Figure 10. Channel Info Tab

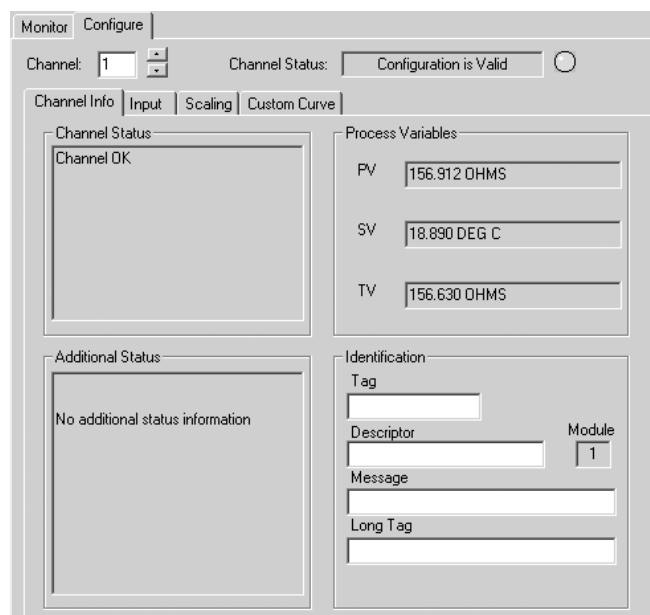

Channel Status– Status, errors and any other messages are displayed in this area.

Additional Status– Displays HART Command 48–*Read Additional HART Status* information. Refer to Table 9 for detailed information.

Process Variables (PV/SV/TV)– Displays the present Process Variable readings.

Tag– Use this section to place an identifying tag (8 alphanumeric characters, maximum) to the displayed channel.

Descriptor– Use this area to place a description for this channel (16 alphanumeric characters, maximum).

Message– Use this area to place a message, or notation for this channel (32 alphanumeric characters, maximum).

Long Tag–This allows for a longer Tag identifier (up to 32 alphanumeric characters, maximum). Use this section if a more detailed tag is needed.

If in TCS mode, the number in the *Module* box will reflect the module number that has been set in the PC Configuration Software's *Information* section (left-pane of the screen).

Input Tab

Figure 11. Input Tab

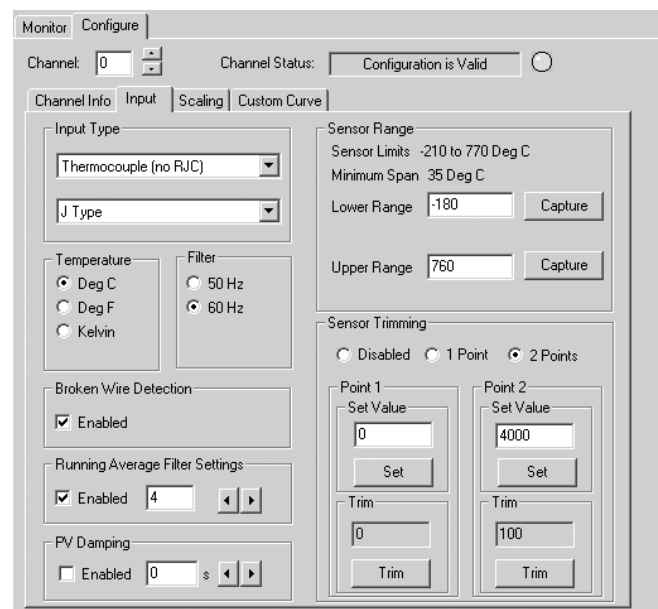

Input Type– Select your input type and the respective range of your input.

Temperature / SV Temperature– Use this section to select the temperature unit you wish to view.

If the selected *Input Type* is an RTD or T/C, this section is displayed as *Temperature*.

If a mV, Resistance or Potentiometer input is selected, this section is displayed as *SV Temperature*. The SV (HART Secondary Variable) Temperature being displayed is the ambient, or reference junction, temperature of the TCM.

Filter– This setting is used to configure the input filter. The filter is designed to reduce the effects of mains-induced noise. The input filter frequency value should be set to the frequency of the local AC supply—either 50Hz or 60Hz.

Broken Wire Detection— During operation, the TCM sends random microamp pulses through input wiring to check for broken wiring or a burned out sensor.

To utilize *Broken Wire Detection*, check the *Enabled* box. If a failure is detected, a message will appear in the *TCM Status* box.

Running Average Filter Settings— This function is for filtering the input signal. The TCM provides this filter with a user-selected range between 1 and 16. Factory default is 4.

Note:

A higher Running Average Filter setting provides smoother output transitions; however, reduces response time. Conversely, a lower setting provides a faster response time, but may seem more unstable.

PV Damping—PV Damping allows you to introduce a delay into the response of your unit in order to stop short-lived spikes from initiating faults and generating fault messages.

The configured damping period will determine the time response that the analog output will take to achieve a 63.21% change in output in response to a stepped input.

To enable PV Damping, select the *Enabled* button. Use the arrows to select a value between 1sec and 30sec.

Sensor Range— Allows you to set your upper and lower range values within the range chosen in the *Input Type* section.

The desired Upper and Lower Range settings can be entered via your PC keyboard or captured. To capture an input, follow the steps below.

1. Apply the desired Upper Range input and press the corresponding *Capture* button.
2. Next, apply the desired Lower Range input and press the corresponding *Capture* button.

Sensor Trimming— Sensor Trimming increases the measurement accuracy of your instrument by matching the reading of its actual input, to either a calibrated source or the device to which it is connected. This verifies that the input to the transmitter is being interpreted correctly.

You may trim any point between 0% and 100% along the scale. Note that one-point trimming applies an offset to the sensor reading, while two-point trimming applies both an offset and a gain.

Follow the steps below in order to perform sensor trimming.

1. Select either *1 Point* (one-point trimming) or *2 Points* (two-point trimming) by clicking the appropriate button. Each pair consists of *Set Value* and *Trim* fields.
2. Enter the values that require trimming into the *Set Value* field and click *Set*.
3. Apply the targeted signal to the input, wait until it settles, and click *Trim* to capture the measured value. If you chose *2 Points*, repeat the step above for the second point.

Note:

*Once you have configured all parameters, download to the unit by selecting *Download* in the *Transfer* dropdown menu located in the *Menu Bar*. Or, click the button in the *Tool Bar*.*

Scaling Tab

Figure 12. Scaling Tab

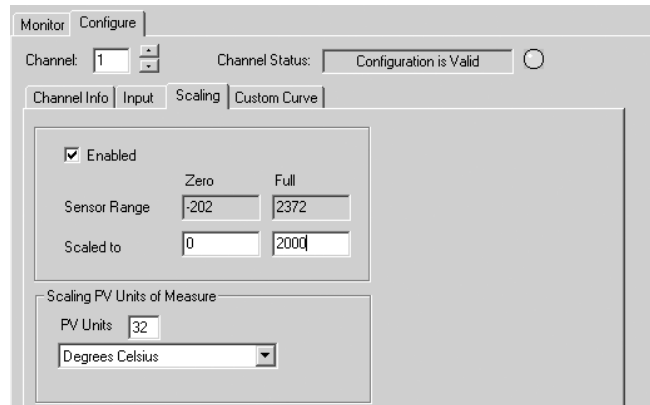

Note:

Using the Scaling feature will disable the Custom Curve capability. Since both are scaling features used to manipulate the appearance of your process variable, only one of these functions may be used at a time.

Scaling– This allows you to scale the output for your application. By example, if your process is sending a -200°C to 850°C signal to the TCM and you wish to view the input as 0-100% then this can be accomplished with the scaling feature.

To scale your instrument, perform the following steps:

1. Check the *Enabled* box. The *Sensor Range* boxes will display the range selected in the *Input Type* section of the *Input* screen.
2. In the *Scaled to* text boxes, enter the values you wish displayed when your input is at its Zero Range and Full Range.

Scaling PV Units of Measure– Use this to select a preset HART EGU process variable display for your scaled values. These HART EGU codes are compatible with HART Revision 5, and earlier, communications.

Note:

Once you have configured all parameters, download to the unit by selecting *Download* in the *Transfer* dropdown menu located in the *Menu Bar*. Or, click the  button in the *Tool Bar*.

Custom Curve Tab

Figure 13. Custom Curve Tab

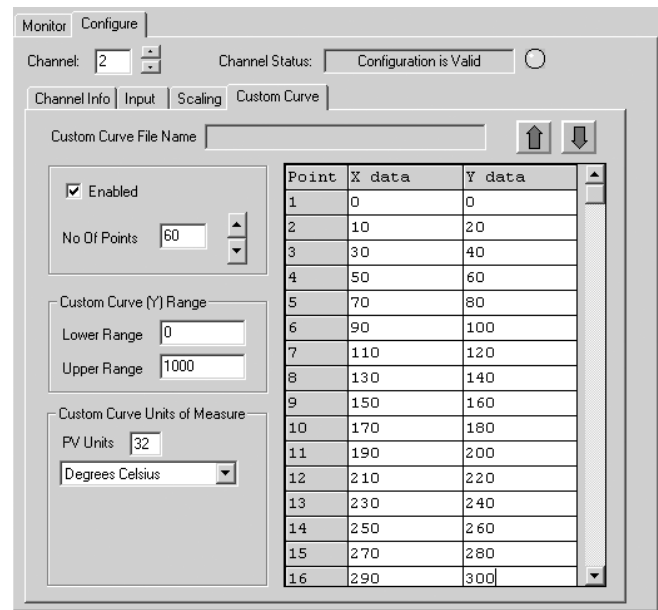

Note:

Using the Custom Curve feature will disable the Scaling capability. Since both are scaling features used to manipulate the appearance of your process variable, only one of these functions may be used at a time.

Custom Curve–The Custom Curve feature allows you to set up your own custom curve table. This feature will scale the different input values based on the X, Y coordinates in the table. This feature also allows you the ability to write a table in Microsoft® Excel, save it in a .csv format, and import it into the Configuration Software. This makes it simple to save the custom table for downloading to multiple units or for backup purposes.

To create a custom curve:

1. Click the *Enabled* box.
2. Select the number of points for your curve (128 points maximum) and enter it into the *No Of Points* text box.
3. In the *Custom Curve (Y) Range* text boxes, enter the values to scale the output.
4. Type your individual values in the *X data* and *Y data* columns. Source variables are inserted into the X Column, while the corresponding data is inserted into the Y Column.
5. After all of your data has been entered, you may use the *Custom Curve* dropdown menu in the Menu Bar to save your newly created custom table (*Save Custom Curve*) and to download it to your TCM (*Download Custom Curve*) or simply click the up and down arrows found in the upper-right section of the *Custom Curve* screen.

Custom Curve Units of Measure– Use this to select a preset HART EGU process variable display for your custom curve values. These HART EGU codes are compatible with HART Revision 5, and earlier, communications.

Note:

Once you have configured all parameters, download to the unit by selecting *Download* in the *Transfer* dropdown menu located in the *Status Bar*. Or, click the  button in the *Tool Bar*.

Additional Features

This section describes features that are configurable through the Menu and Tool Bar.

Searching for a Connected TCM Module

If using HART Communications and you need to search for a connected TCM with an unknown address on a specific COM port, you can perform a TCM search. The first device to respond stops the search and the device's configuration is uploaded to the PC Configuration Program. When in *TCS* mode, the information returned also includes the module number of the TCM.

To begin a TCM search, you may either click the  button in the tool bar or select *Find TCM* from the *Transfer* dropdown menu. You can view search progress in the *Module* box located in the *Communications* section of the PC Configuration Program.

Import/Export Configurations

Found in the *Channel Configuration* dropdown menu, the *Import/Export Wizard* helps to easily import and export configurations between channels and allows you to save and load configurations from files on your computer.

Once you have initialized the *Import/Export Wizard* follow the prompts throughout the program.

Using the HART Communicator

If your hand-held communicator (HHC) is equipped with the Device Description (DD) for your transmitter, *The HART Communicator Menu with a Device Description* section gives an overview of the menus and instructions for programming.

To determine if your communicator has the appropriate Device Description, press **1** to select *Offline* and press **1** again to select *New Configuration*. A list of companies will appear which, if you have the appropriate Device Description, will include Moore Industries' TCM.

If your communicator is *not* equipped with the required Device Description, go to *The HART Communicator Menu without a Device Description* section of this manual. Some capabilities can only be accessed if your communicator is equipped with a Device Description.

Note:

To use a hand-held communicator with the HMC on the bus, uncheck the TCM Enabled boxes and then download the instrument configuration to the HMC.

If you are using a Fisher-Rosemount Model 375 HART Communicator, the DD is available via download. Contact Moore Industries for more information.

If you are using a Fisher-Rosemount Model 275 or 475 HART Communicator and require the latest version of the DD, you must send the Communicator to Moore Industries. To send the instrument to Moore Industries contact our Customer Service department for a Returned Material Authorization (RMA).

Include Moore Industries' configuration sheet indicating the Device Descriptions that you require. We will load the Device Descriptions of your choice for a nominal charge.

Programming When a Device Description is Available

Note:

All parameters, except the Custom Curve feature, can be configured using the HART Communicator. The Custom Curve table can only be configured using the PC Configuration Software Program.

With the transmitter connected as illustrated in Figure 3 apply power and turn on the communicator. After a brief self-test, the communicator will show the main menu and identify the unit as a TCM.

This section contains the instructions for programming the transmitter using a HART Communicator that has been programmed with a HART Device Description. If your communicator does not have the appropriate Device Description, skip to *The HART Communicator Menu without a Device Description* section of this manual.

Figure 9 shows an overview of the programming menus for the configuration process.

Figure 14. TCM HART Communicator Configuration Menu Summary

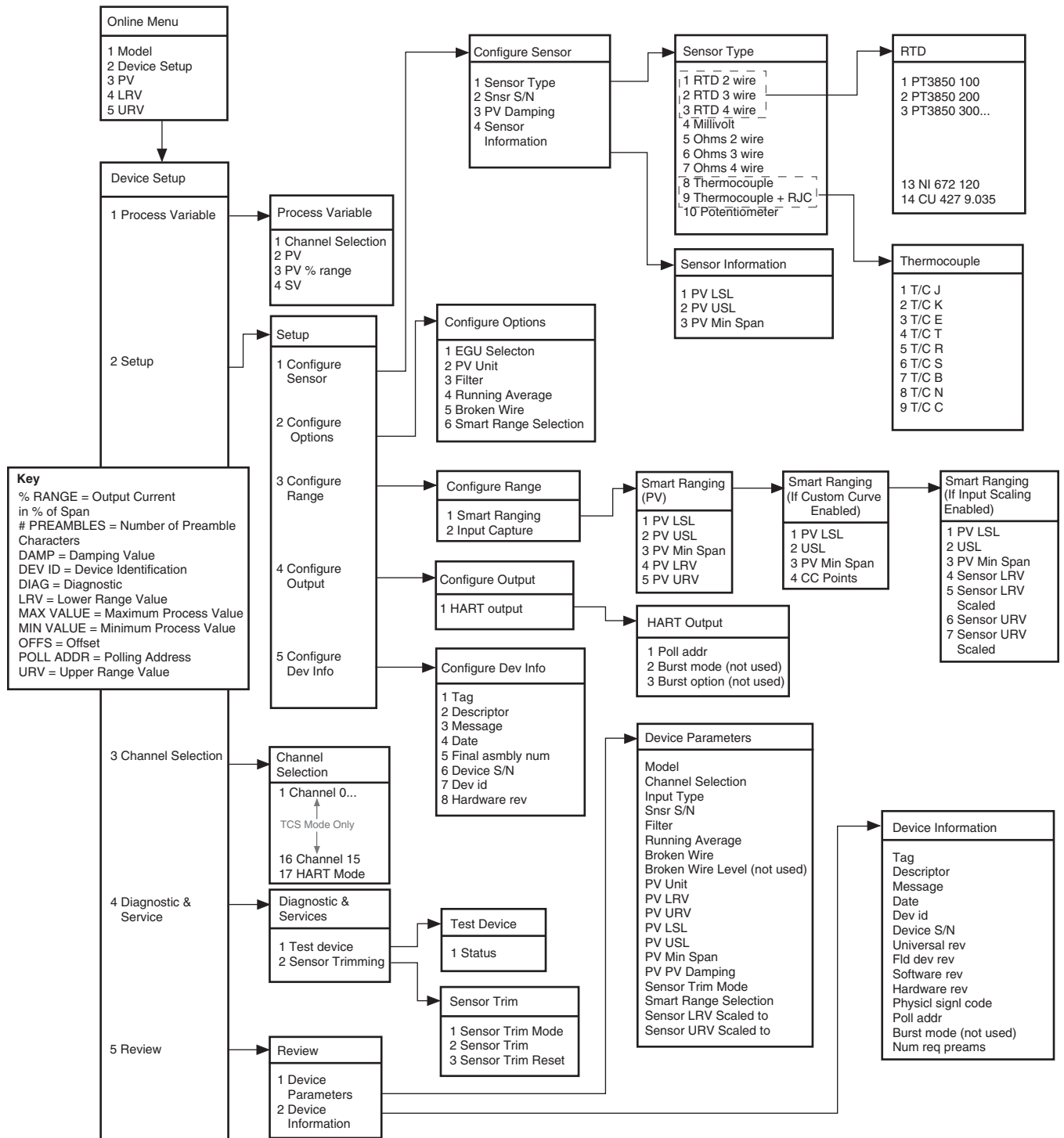

The HART Communicator Menu With a Device

Description

To program your TCM, if your communicator is equipped with the Device Description for your instrument, follow the steps below. Refer to Figure 14 for menu parameters of steps outlined below.

Online Menu

The *Online* menu displays the process value as well as the lower/upper range scaled values of your application (all parameters are read-only except for *Device Setup*). Use the *Device Setup* menu to configure the TCM.

Device Setup Menu

The *Device Setup* menu allows you to access the following sub-menus: *Process Variable, Setup, Channel Selection, Diagnostic & Services and Review*. Each of these sub-menus is explained below.

Note:

The Mode Setting must be set before any configuration. This will insure that the correct MODE is active. Refer to Channel Selection to on page 23 to set Mode.

Process Variable Menu

The *Process Variable* menu is a read-only display that indicates the selected channel, process variable, output in percent of span (% range) and the secondary variable.

Setup Menu

Scroll through the *Setup* menu to access configuration menus for the following parameters: *Configure Sensor, Configure Options, Configure Range, Configure Output* and *Configure Dev Info*.

Setup menu parameters are detailed below.

Configure Sensor

This menu allows access to sensor configuration.

1 Sensor Type– Select the sensor type you will use (RTD, Ohms, T/C or Potentiometer). You will navigate through sub-menus depending upon parameters that are being set.

2 Snsr S/N– Assign a unique serial number to your sensor.

3 PV Damping– Allows you to introduce a delay into the response of your unit in order to stop short-lived spikes from appearing as faults and generating fault messages. The allowable PV Damping range is 0sec to 30sec.

4 Sensor Information– Displays the Upper Sensor Limit (USL), Lower Sensor Limit (LSL) and minimum span of the selected sensor type.

Configure Options

You may configure the following options from this menu:

1 EGU Selection– Choose the EGU you wish displayed.

2 PV EGU– View the existing EGU setting.

3 Filter– This is used to configure the input filter which helps reduce mains-induced noise. The value selected should match the frequency of the local AC supply (50Hz or 60Hz).

4 Running Average– This feature filters the input signal. The TCM provides this feature with a user-selected value between 1 and 16. Factory default is 4.

Note:

A higher Running Average setting provides smoother output transitions, however, will reduce response time. Conversely, a lower setting provides a faster response time, but may seem more unstable.

5 Broken Wire– If enabled (by selecting *On*) the TCM sends random microamp pulses through input wiring to check for broken wiring or a burned out sensor.

6 Smart Range Select– Select whether you choose to view the process variable, use a custom curve table or scale the input. Custom curve can only be set using Moore Industries' PC Configuration Software. Input scaling configuration is performed in the *Configure Range* menu.

Configure Range

Within the *Configure Range* menu are the capabilities to configure Smart Ranging and capture the input.

1 *Smart Ranging*– Configuration steps will vary depending on whether *PV*, *Custom Curve* or *Input Scaling* was selected in the *Configure Options* menu.

PV

1 *PV LSL*– Displays the lower sensor limit (LSL) of the attached sensor.

2 *USL*– Displays the upper sensor limit (USL) of the attached sensor.

3 *PV Min Span*– Indicates the allowable minimum difference between the upper range value (URV) and lower range value (LRV).

4 *PV LRV*– Enter the value you wish displayed as your lower range value when your process variable is output at its lower end (0%).

5 *PV URV*– Enter the value you wish displayed as your upper range value when your process variable is output at its upper end (100%).

If Custom Curve is Enabled

1 *PV LSL*– Displays the lower sensor limit (LSL) of the attached sensor.

2 *PV USL*– Displays the upper sensor limit (USL) of the attached sensor.

3 *PV Min Span*– Indicates the allowable minimum difference between the upper range value (URV) and lower range value (LRV).

4 *CC Points*– Displays the number of Custom Curve points you have enabled (2 to 128 points).

If Scaling is Enabled

1 *PV LSL*– Displays the lower sensor limit (LSL) of the attached sensor.

2 *PV USL*– Displays the upper sensor limit (USL) of the attached sensor.

3 *PV Min Span*– Indicates the allowable minimum difference between the upper range value (URV) and lower range value (LRV).

4 *Sensor LRV*– Enter the sensor's lower range value (LRV).

5 *Sensor LRV Scaled*– Select the value you wish as

your scaled LRV (for 0% value). Allowed span is from -99999 to 99998.

6 *Sensor URV*– Enter the sensor's upper range value (URV).

7 *Sensor URV Scaled*– Select the value you wish as your scaled URV (for 100% value). Allowed span is from -99998 to 99999.

Configure Output

This menu allows you to configure your instrument's HART output. Use this portion of the menu to configure the Poll Address.

1 *Poll addr*– The HART polling address is represented by a number between 0 and 15 while in *HART* mode. When in *TCS* mode, addresses 1 and 2 are used.

Configure Dev Info

This menu allows you to configure identification parameters for your TCM.

1 *Tag*– Place a unique label that corresponds to your instruments location or specific usage (8 characters maximum).

2 *Descriptor*– Place text that is used as a description of how the instrument is being used (16 characters, maximum).

3 *Message*– Place additional information that may be helpful in describing the instrument or its use (32 characters, maximum).

4 *Date*– Store a date that corresponds to specific system function, i.e. instrument configuration date, calibration due date, preventive maintenance schedule, etc.

5 *Final asmbly num*– You may enter a number that is used for identification purposes, and is associated with the field device (8 characters, maximum).

6 *Dev id*– This is a read-only value that uniquely identifies the field device when combined with the manufacturer identification and device type.

7 *Hardware rev*– This value corresponds to the revision of the electronics hardware of the field device.

TCS

Temperature Concentrator System™
Multi-Channel Transmitter

Channel Selection

Allows you to select between *TCS* or *HART* mode*. If choosing a channel to monitor (Channel 1 through Channel 16), *TCS* mode is enabled. *HART* mode is enabled by scrolling to the end of the channel menu (Channel 17). When in *HART* Mode each device (1 to 16) is each treated as an individual channel.

Note:

**Correct Mode must be selected in order to properly configure system.*

Diagnostic & Service Menu

Allows you to perform diagnostic functions and sensor trimming.

1 Test device– Directs you to a *Status* sub-menu. When accessed, it causes the TCM to perform a self test of its electronics. Any errors that occur are reported on the communicator.

2 Sensor Trimming– This menu allows you to view previously configured Sensor Trim Mode settings and perform the sensor trimming procedure.

Review Menu

This is a read-only menu that provides information on both *Device Parameters* and *Device Information*. Refer to the *Review* menu portion of Figure 13 for a description of the parameters included in this menu.

The HART Communicator Menu Without a Device Description

This section contains the instructions for programming the TCM using a HART communicator without a Device Description. If your communicator has a Device Description, please see *The HART Communicator Menu with a Device Description* section of this manual.

Note:

Without a Device Description, you may only program the TCM in HART mode.

Online Generic– The initial screen, the *Online Generic* menu, displays the process value and the programmed upper and lower parameters of the process value. The generic HART Communicator overview menu (Figure 10) shows the menu. Use the *Device Setup* menu to configure your TCM.

Basic Setup– The *Basic Setup* menu allows you to enter a name for an individual transmitter, the units of measurement, the upper and lower range and sensor values, and a damping time between 0sec and 30sec.

HART Output– From the *HART Output* menu, you can enter the polling address and display the number of preamble characters sent by the master to the slave to ensure synchronization.

Figure 15. Generic HART Communicator Menu Overview

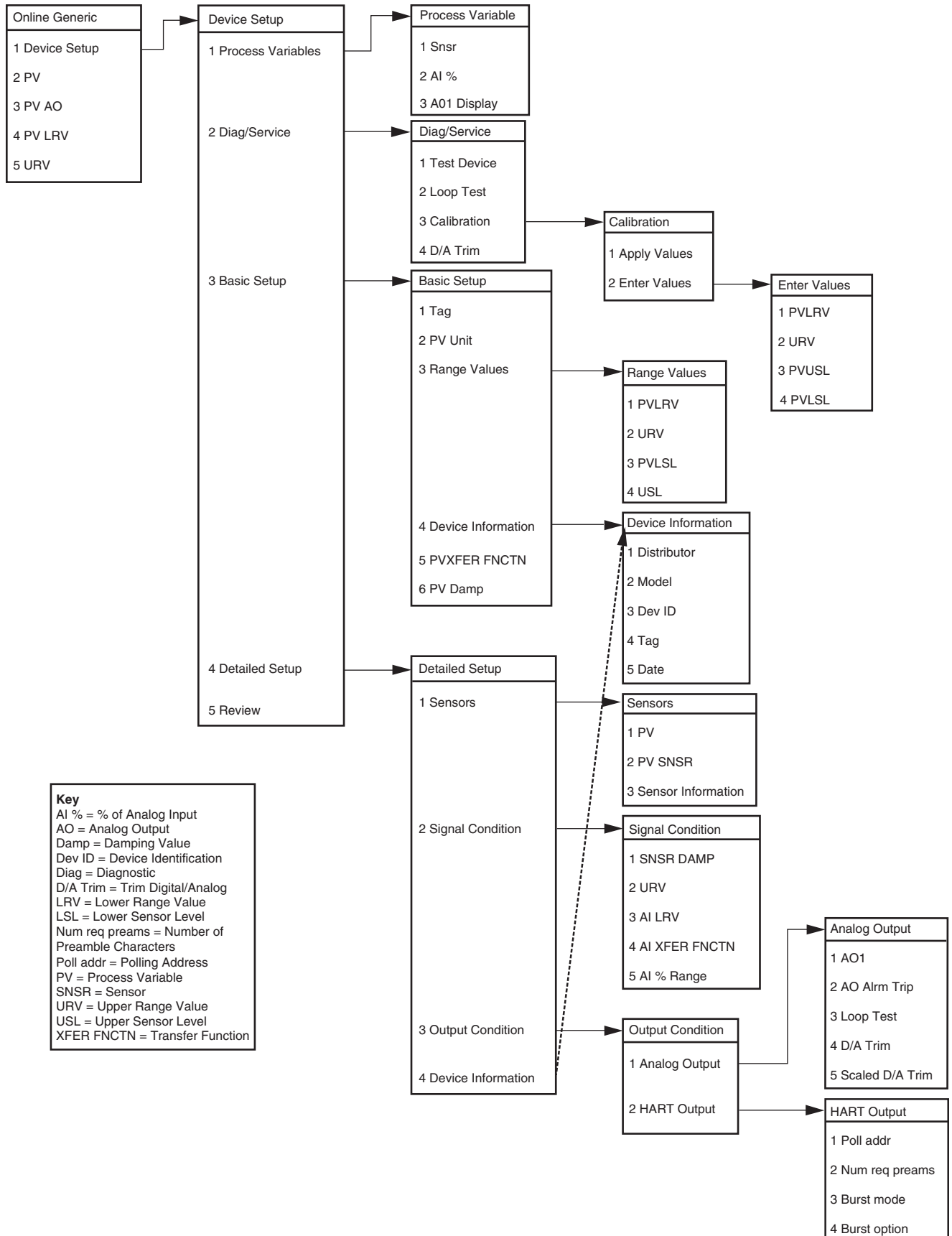

HART Status Information

Each time the TCM generates a response, frame status information is included in the reply message. The first byte indicates communications errors, if any. Otherwise, if communication was good, this byte may indicate the status of the received command (such as transmitter busy or a command not supported). The second status byte indicates the operational state of the slave device. A properly operating slave device will have both status bytes set to logic zero.

The following tables include the common information that is returned in every response message.

Table 6. Communication Errors

Bit 7 = 1	
Bit	Description
0	Undefined
1	Buffer overflow
2	Reserved set to zero
3	Checksum error
4	Framing error
5	Overrun error
6	Parity error
7	This bit is always set when communication errors occur

TCM 1 Register Range 1513 or
TCM 2 Register Range 1514
See Table 12

Table 7. Command Errors

Bit 7 = 0		
Value	Hex	Description
0	0x00	No command errors
1	0x01	Undefined error
2	0x02	Invalid selection
3	0x03	Passed parameter too large
4	0x04	Passed parameter too small
5	0x05	Too few bytes received
6	0x06	Transmitter specific command error
18	0x12	Invalid UOM code
32	0x20	Transmitter busy
64	0x40	Command not supported

TCM 1 Register Range 1513 or
TCM 2 Register Range 1514
See Table 12

Table 8. HMC Status Information

Bit	Definition
0	Hardware failure
1	EEPROM failure
2	Configuration data checksum error
3	Calibration data checksum error
4	EEPROM blank
5	Out of range error
6	Division by zero error
7	Configuration data bad
8	COP watchdog
9	RAM test failure
10	ROM test failure
11	Software watchdog failure
12	Software sequence of event error
13	Not used
14	HART device malfunction bit set
15	No HART communications

HMC MODBUS Register 2001
See Table 12

Table 9. TCM channel status

Bit	Hex Value	Description
0	0 X 01	Not Used
1	0 X 02	Wire(s) or RJC broken
2	0 X 04	ADC Failure
3	0 X 08	Bad custom curve
4	0 X 10	Input saturated
5	0 X 20	Out of Range
6	0 X 40	Not Used
7	0 X 80	Not Used

HMC MODBUS Register 1001-1032
See Table 12

HART Command 48

The *Additional Status Information* section in the *Channel Info* tab displays six additional HART status information bytes in response to HART Command 48—*Read Additional HART Status Information*.

The six data bytes are described in Table 10.

Table 10. HART Command 48 Data Bytes

Status Byte	Status Word Bit	Type	Description
0	0	Error	Configuration data error
	1	Error	Calibration data error
	2	Error	EEPROM blank
	3	Error	EEPROM failure
	4	Error	Division by zero error
	5	Error	RJC Broken
	6	Error	Software watchdog failure
	7	Error	COP watchdog failure
1	0	Error	Sensor wire 1 broken
	1	Error	Sensor wire 2 broken
	2	Error	Sensor wire 3 broken
	3	Status	Sensor wire 4 broken
	4	Status	Out of range error
	5	Status	Input Saturation
	6	Status	Busy / Calibration, trimming active
	7	Error	Configuration data area checksum error
2	0	Error	Calibration data area checksum error
	1	Error	ADC Error
	2	Error	Bad custom curve
	3	Error	Front-end / Back-end communications failure
	4-7	Not used	Set to zero
3	0-7	Not used	Set to zero
4	0-7	Not used	Set to zero
5	0-7	Not used	Set to zero

The Hart-to-MODBUS Converter

The following section describes use and configuration of the Hart-to-MODBUS Converter (HMC).

The HMC operates in HART primary master mode communicating with either one or two TCMs, reading the TCM's variables through its HART interface. The HMC is used to convert the TCM variables to MODBUS communication, through its dual MODBUS ports.

The HMC only talks to addresses 1 and 2. One address is assigned to one of the TCMs in the system (a maximum of two are allowed). Since the TCM outputs are seen as 16 channels from one device when in TCS mode, each address displays the status information from each channel of the TCM to which it is assigned.

MB Output

The HMC has dual MODBUS ports for redundancy. Slave address, baud rate and character format are user-configurable (both ports use the same slave address, baud rate and character format).

Fault Alarms

As an added measure, the HMC comes standard with two alarms (relays). The relay is energized when the attached device is operating properly. It is rated at 2A @250Vac (non-inductive loads, 50/60Hz). The relays can be set to send a master alarm when the HMC detects one, any, or all of the following fault conditions within the system: No HART signal; broken wire; hardware error; bad configuration; input saturated; and input out of table range.

The alarms can be set with a time delay, which specifies how long (in seconds) the alarm condition needs to exist before the alarm trips. Failsafe and Non-Failsafe alarm action is also configurable.

The HMC's front panel has four dual color LEDs. The *Fault1* and *Fault2* LEDs display alarm status. Green indicates no alarm condition and red indicates an alarm condition. If only one TCM is enabled in the system, then the unused Fault LED will always be green.

Refer to the *Alarms* tab section for configurable alarm parameters.

TX Power

A transmitter excitation (TX) power supply (26Vdc \pm 3% @40mA) is standard on the HMC. This allows you to power up to two TCMs without the need for an external power supply. Refer to Figure 17 for hook-up.

Configuring the HMC

All operating parameters are set using a PC and Moore Industries' Intelligent PC Configuration software.

Configuration parameters are stored in the instrument's memory and can be saved on your PC hard drive or external media. The transmitter communicates with the PC through an RS-232 port or optional USB cable.

Installing the Configuration Software

Refer to Table 11 for the equipment needed.

1. Insert the *Moore Industries Interface Solution PC Configuration Software* CD into the CD drive of the PC. Access the CD and open the *HMC PC Configuration Software* folder.
2. Double-click the installation program located in the folder. Follow the prompts to correctly install the program.

Once the Configuration Program is installed on the PC, the HMC can be connected to equipment to monitor output. You can then change the transmitter's operating parameters.

It is not necessary to connect the HMC to a PC to create configuration files when using the PC Configuration Software. The program can be run without connecting a HMC, and **most** parameters can be set without input from the instrument.

This makes it easy to create a set of operating parameters, save them to external media, and download them to one or more instruments at a later time.

The HMC **must** be connected to the PC in order to receive (via download) a configuration file and save the configuration file from its memory.

Connecting the HMC to the PC

To connect the HMC to a PC, simply power the instrument using a 24Vdc power supply and then connect it to the PC via the RS-232 serial port using the Moore Industries Interface Cable or optional USB cable listed in Table 11.

Refer to the *Recommended Ground Wiring Practices* section of this manual for information regarding grounding the HMC.

HMC Specifications

<p>Performance Input Accuracy: Reflects the accuracy of the TCM Input Impedance: Transmit Mode: 150 ohms; Receive Mode: Greater than 5kohms Maximum Input Over-Range: ±5Vdc Isolation: 1000Vrms between case, input, MODBUS outputs and power terminals, continuous, and will withstand 1500Vac dielectric strength test for one minute (with no breakdown) Power Supply: 24Vdc, nominal; 20-30Vdc limits Power Consumption: 4-7W, nominal; 9W @24Vdc, maximum for units using TX +TX Power Supply: 25.8Vdc ±3% @40mA Digital Response Time: 1 second from TCM input to MODBUS output; MODBUS response time depends on how fast and how often a MODBUS Master requests data from the HMC; the data response time from request is 50msec</p>	<p>Performance (Continued) Alarm Response Time: Digital Response Time + 150msec, maximum (defined as the time from when the field instrument reports a fault until the HMC alarm is tripped) Alarm Trip Delay: Programmable from 0-120sec Output Type: Standard MODBUS RTU protocol interface over RS-485 (parameters as specified in U.S. Standard EIA-RS485) Address Range: Configurable from 1 to 247. Unit will assume a MODBUS address of 1 by default Baud Rate: Interface supports the following: 300, 600, 1200, 2400, 4800, 9600 and 19.2k. Unit will assume a baud rate of 9600 and no parity by default Parity: MODBUS interface will support even, odd or no parity Character Format: One start bit, 8 data bits and one stop bit Data Format: User-selectable; Standard LSW (Least Significant Word) first or Swapped MSW Most Significant Word) first. Unit will assume Standard LSW by default.</p>	<p>Indicators LED Type: Dual color red/green indicate: INPUT LED: Input is present and normal (green); input signal is not found (red) READY LED: Instrument is ready for operation and configuration (green); instrument has encountered an internal problem (red) FAULT 1: Shows status of TCM 1. No alarm condition (green); Instrument is in an alarm state (red) FAULT 2: Shows status of TCM 2. No alarm condition (green); Instrument is in an alarm state (red)</p> <p>Ambient Conditions Operating and Storage Range: -40°C to +85°C (-40°F to +185°F) Relative Humidity: 0-95%, non-condensing RFI/EMI Immunity: 20V/m@80-1000MHz, 1kHz AM, when tested according to IEC61326 Noise Rejection: Common Mode: 100dB @50/60Hz</p> <p>Weight 454g (1.0 lb)</p>
---	--	---

Specifications and information subject to change without notice.

TCS

Temperature Concentrator System™
Multi-Channel Transmitter

Figure 16. HMC Dimensions

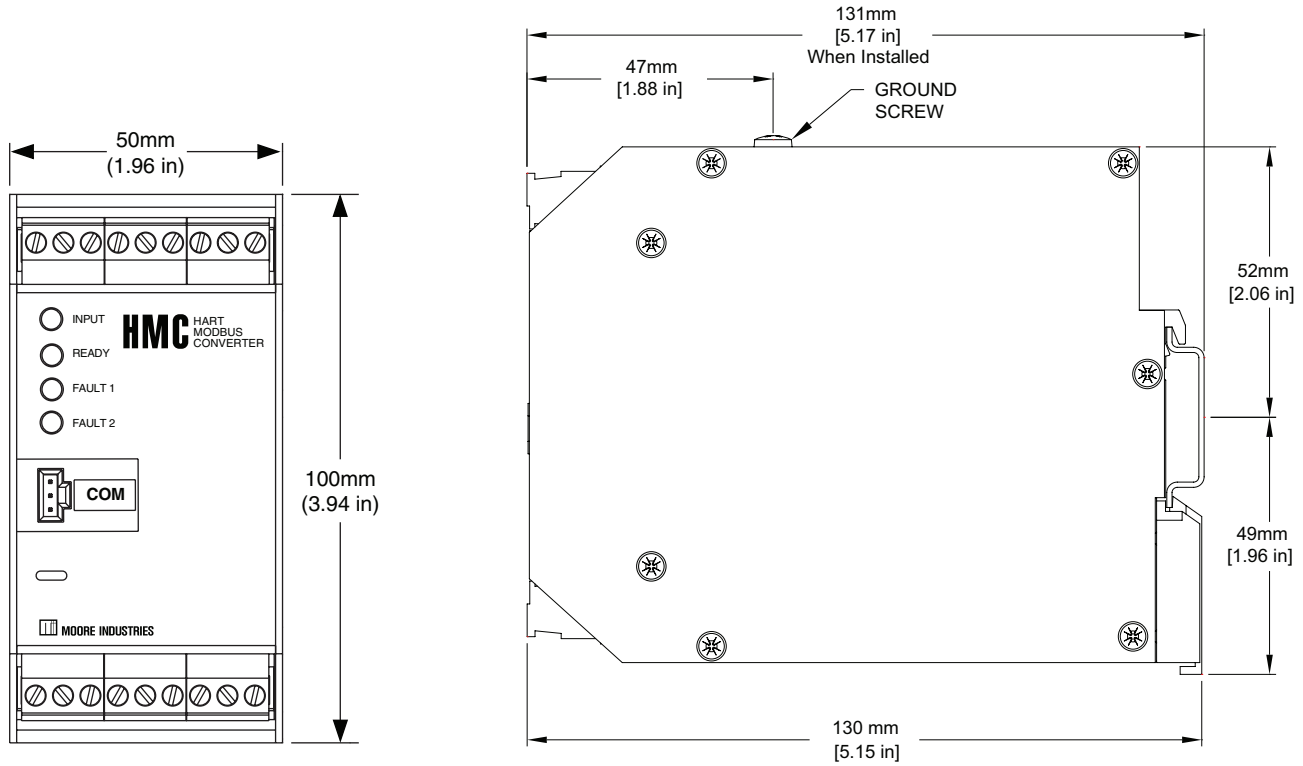

Figure 17. HMC Terminal Designations

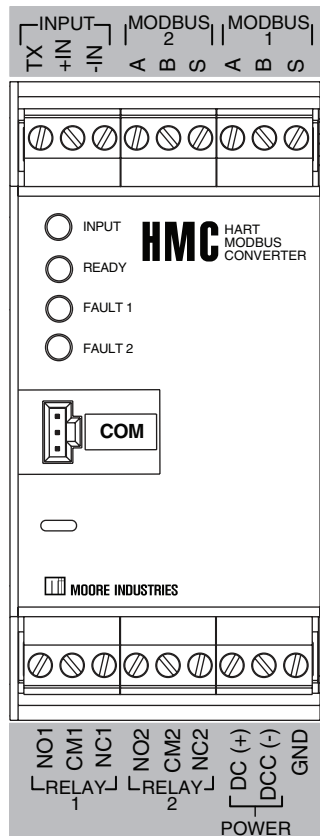

Figure 18. HMC Configuration Hook-Up

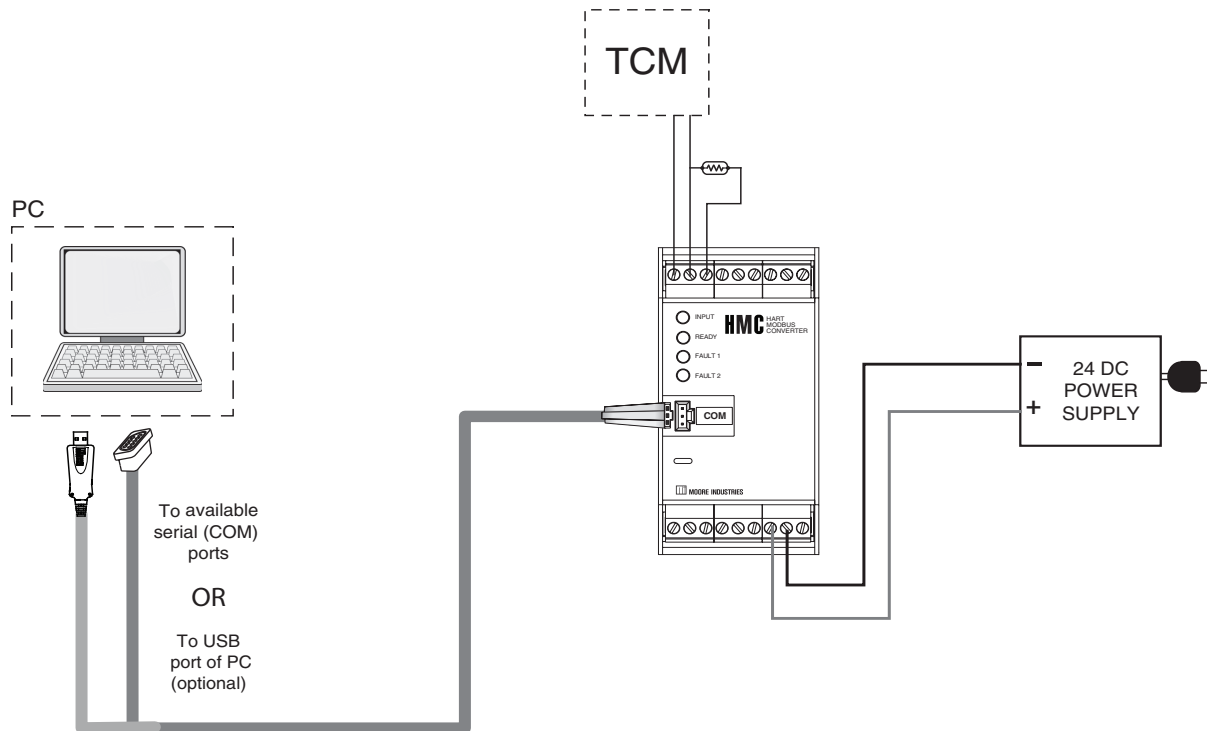
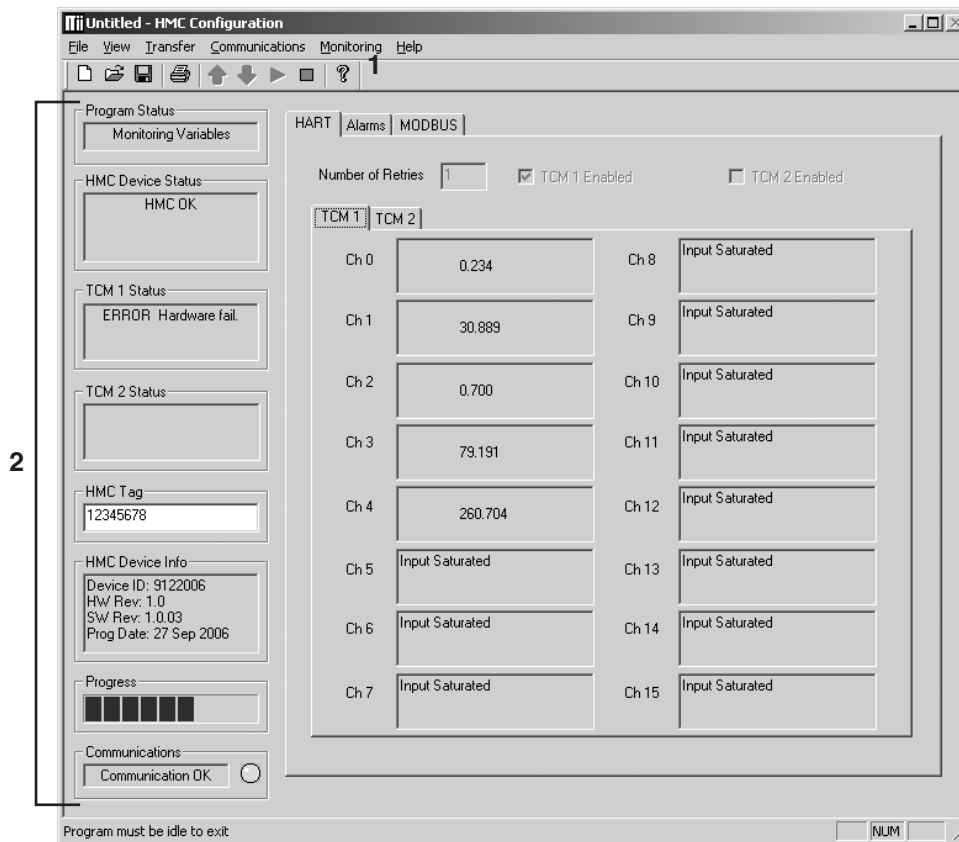

Table 11. Necessary Equipment Table for the HMC and TCS

Device	Specifications
Power Supply	24Vdc, $\pm 1.0\%$ (for HMC and TCS) 26Vdc, $\pm 1.0\%$ (for Intrinsically-Safe TCM applications only)
*Precision Load Resistor (when configuring a TCM system only)	250 ohms, $\pm 0.01\%$ (for TCS only); 100 to 125 ohm, $\pm 0.01\%$ (for Intrinsically-Safe TCM applications only)
Personal Computer (Required only if using a PC for setup)	Pentium-based PC, or equivalent with: CD Drive, 4Mb free RAM (8Mb recommended); 20Mb free disk space on hard drive Operating System: Microsoft Windows® XP, Vista, 7 or 10 1 (one) serial port or USB port
Moore Industries Communication Cable	Part# 803-040-26 (for a 9-pin serial port) or 804-030-26 (for a USB port).
Moore Industries PC Configuration Software	Version 1.0 or greater, successfully installed onto the hard drive

HMC PC Configuration Software Summary

Figure 19. HMC PC Configuration Software Main Screen



Once the default configuration has been saved to your PC or external media, it is safe to program other parameters. The PC Configuration Software program is made up of these sections:

1. Menu Bar/Tool Bar– Dropdown menus and corresponding icons allow you to perform various functions throughout the PC Configuration Program. Refer to the *Menu and Tool Bar Legend* for a complete description.

2. Program Status– This portion of the program displays the activity of the connected unit such as: Idle, Monitoring, Uploading and Downloading.

HMC Device Status– Indicates if there are problems or faults with the instrument.









TCM 1 / TCM 2– Indicates channel status of associated TCM.

HMC Tag– Use this section to place an identifying tag (8 alphanumeric characters, maximum) to your instrument.

HMC Device Info– Indicates device identification.

Communications– Notifies user of current PC connection/communications status.

Menu and Tool Bar Legend

		Allows New/Open/Save File and Print functions
		Controls whether Menu and Tool Bars are viewed on the screen
		Allows you to Upload and Download configurations
		Allows selection of PC COM ports
		Allows you to Monitor and Stop monitoring processes
		Displays the version of the PC Configuration Program and the Help file

Configuration Screens

Note:

Unless otherwise noted, ensure that the PC Configuration Program is idle before making any selections or configuration changes to the program. Also, when attempting to download or upload, monitoring must be stopped. To do this, click Stop in the Monitoring dropdown menu, or click the Stop Monitoring icon on the Tool Bar.

HART Tab

Figure 20. HART Tab

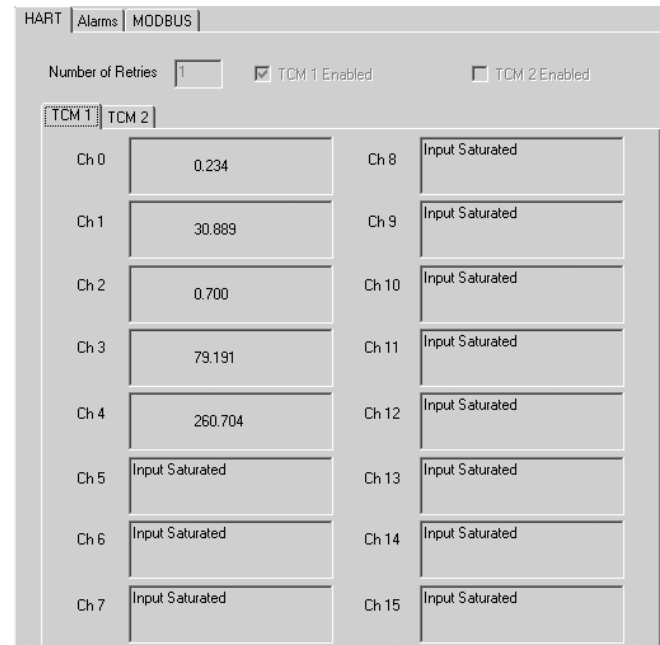

Number of Retries– The *Number of Retries* can be set between 1 and 9 (default is 3), and will determine how many times the HMC will attempt to poll the HART transmitter (without success), before it indicates a HART Fault condition.

TCM 1 / TCM 2– Displays the PVs and status of the channels of the connected TCM.

Check the *Disabled* box to if you prefer not to view status (you may disable either one or both connected TCMs). It is recommended that you disable the second TCM if only one TCM exists on the bus.

TCS

Temperature Concentrator System™
Multi-Channel Transmitter

Alarms Tab

The information below applies to both *TCM1* and *TCM 2 Alarm* sections.

Figure 21. Alarms Tab

The screenshot shows the 'Alarms' tab with two columns for 'TCM 1 Alarm' and 'TCM 2 Alarm'. Each column has a list of checkboxes for alarm conditions: 'No HART', 'Broken Wire', 'Hardware Error', 'Bad Configuration', 'Input Saturated', and 'Input Out of Table Range'. Below each list is a 'Delay (s)' input field (set to 0) and a 'Fail Safe' checkbox (checked).

The TCM Alarm boxes allow you to choose the parameters that will trigger an alarm on the HMC. You may choose any combination of: *No HART* (no HART response received from the TCM (i.e. TCM is not connected)), *Broken Wire*, *Hardware Error*, *Bad Configuration*, *Input Saturated* or *Input Out of Table Range*.

Delay and Failsafe– By entering a value in the *Delay* box, you can specify how long (in seconds) the alarm condition needs to exist before the alarm trips.

Checking the *Fail Safe* box causes the relay to de-energize when in an alarm condition. By not checking the box you place the relay in Non-Fail Safe mode (the relay energizes when tripped).

MODBUS Tab

Figure 22. MODBUS Tab

The screenshot shows the 'MODBUS' tab with several sections: 'Communications' (MODBUS Address (Dec) set to 1, Baud Rate set to 9600, Parity set to None), 'Floating Point Word Order' (Standard LSW selected), and 'Failed TCM's Register Value' (Hold Last selected, Preset to 0, Set to NaN).

MODBUS Address– The *MODBUS Address* is the number that the HMC monitor uses to identify itself on the MODBUS network. The MODBUS address is configurable from 1 to 247. By default, it will assume a MODBUS address of 1.

Baud Rate– The *Baud Rate* is the speed of data transmission. It should be set to match the baud rate of the attached controller. The interface supports the following baud rates: 300, 600, 1200, 2400, 4800, 9600 and 19200.

Parity– The HMC supports even, odd and no *Parity*. The data format is one start bit, 8 data bits and one stop bit.

Floating Point Word Order– By default, the HMC will use the *Standard LSW* (least significant word) floating point word order format. This stores the most significant bits in the second register and the least significant bits in the first register. Selecting *Swapped MSW* (*most significant word*) will reverse the order, storing the most significant bits in the first register and the least significant bits in the second register.

Failed TCM's Register Value– You may select what would occur to a TCM's register value in the event that communication is lost with the HMC.

If selecting *Hold Last* and a failure is detected, the last measured value before the failure occurred is held.

Entering a user-set value in the *Preset to* text box recalls that value when a device failure is detected.

Selecting *NaN* (Not a Number—as put forth by the IEEE-754 standard) causes the floating point NaN value to be stored in the registers used for holding floating point values.

MODBUS RTU Registers

Table 12 describes the 30,000 / 40,000 overlapped register set. Please note that MODBUS is limited to reading 32 registers in a single transfer.

Table 12. MODBUS 30,000 / 40,000 Register Ranges

Register Range	Description
1/2	* TCM 1, Channel 0 PV
3/4	* TCM 1, Channel 1 PV
5/6	* TCM 1, Channel 2 PV
7/8	* TCM 1, Channel 3 PV
9/10	* TCM 1, Channel 4 PV
11/12	* TCM 1, Channel 5 PV
13/14	* TCM 1, Channel 6 PV
15/16	* TCM 1, Channel 7 PV
17/18	* TCM 1, Channel 8 PV
19/20	* TCM 1, Channel 9 PV
21/22	* TCM 1, Channel 10 PV
23/24	* TCM 1, Channel 11 PV
25/26	* TCM 1, Channel 12 PV
27/28	* TCM 1, Channel 13 PV
29/30	* TCM 1, Channel 14 PV
31/32	* TCM 1, Channel 15 PV
33/34	* TCM 2, Channel 0 PV
35/36	* TCM 2, Channel 1 PV
37/38	* TCM 2, Channel 2 PV
39/40	* TCM 2, Channel 3 PV
41/42	* TCM 2, Channel 4 PV
43/44	* TCM 2, Channel 5 PV
45/46	* TCM 2, Channel 6 PV
47/48	* TCM 2, Channel 7 PV
49/50	* TCM 2, Channel 8 PV
51/52	* TCM 2, Channel 9 PV
53/54	* TCM 2, Channel 10 PV
55/56	* TCM 2, Channel 11 PV
57/58	* TCM 2, Channel 12 PV
59/60	* TCM 2, Channel 13 PV
61/62	* TCM 2, Channel 14 PV
63/64	* TCM 2, Channel 15 PV

* Denotes that two 16 bit registers are used to hold an IEEE 32bit floating point value.

Table 12. Continued

Register Range	Description
65 to 512	Reserved for expansion (see Table 9)
1001	TCM 1, Channel 0 Status (see Table 9)
1002	TCM 1, Channel 1 Status (see Table 9)
1003	TCM 1, Channel 2 Status (see Table 9)
1004	TCM 1, Channel 3 Status (see Table 9)
1005	TCM 1, Channel 4 Status (see Table 9)
1006	TCM 1, Channel 5 Status (see Table 9)
1007	TCM 1, Channel 6 Status (see Table 9)
1008	TCM 1, Channel 7 Status (see Table 9)
1009	TCM 1, Channel 8 Status (see Table 9)
1010	TCM 1, Channel 9 Status (see Table 9)
1011	TCM 1, Channel 10 Status (see Table 9)
1012	TCM 1, Channel 11 Status (see Table 9)
1013	TCM 1, Channel 12 Status (see Table 9)
1014	TCM 1, Channel 13 Status (see Table 9)
1015	TCM 1, Channel 14 Status (see Table 9)
1016	TCM 1, Channel 15 Status (see Table 9)
1017	TCM 2, Channel 0 Status (see Table 9)
1018	TCM 2, Channel 1 Status (see Table 9)
1019	TCM 2, Channel 2 Status (see Table 9)
1020	TCM 2, Channel 3 Status (see Table 9)
1021	TCM 2, Channel 4 Status (see Table 9)
1022	TCM 2, Channel 5 Status (see Table 9)
1023	TCM 2, Channel 6 Status (see Table 9)
1024	TCM 2, Channel 7 Status (see Table 9)
1025	TCM 2, Channel 8 Status (see Table 9)
1026	TCM 2, Channel 9 Status (see Table 9)
1027	TCM 2, Channel 10 Status (see Table 9)
1028	TCM 2, Channel 11 Status (see Table 9)
1029	TCM 2, Channel 12 Status (see Table 9)
1030	TCM 2, Channel 13 Status (see Table 9)
1031	TCM 2, Channel 14 Status (see Table 9)
1032	TCM 2, Channel 15 Status (see Table 9)
1033-1256	Reserved for future expansion
1513	TCM 1 Overall Status (see Tables 6 & 7)
1514	TCM 2 Overall Status (see Tables 6 & 7)
1515-1528	Reserved for future expansion
2001	HMC status information (see Table 8)
2002**	Alarm status

** Bit 0 = alarm 1 tripped
Bit 1 = alarm 2 tripped

TCS

Temperature Concentrator System™
Multi-Channel Transmitter

Installation

Installation consists of physically mounting the unit and completing the electrical connections.

Mounting the TCM and HMC

The TCM and HMC can be mounted on 35mm Top Hat EN50022 DIN mounting rails.

Making the Electrical Connections

To install the TCM, refer to Figure 8.

To install the TCS system, refer to Figures 3 and 5. For installation in an intrinsically-safe application refer to Figure 23.

For HART applications, ensure that the loop resistance is between 250 and 1100 ohms. For Intrinsically-Safe applications, use no more than 125-150 ohms due to the internal resistance of I.S barrier.

When installing any Moore Industries product, always follow all local regulations and standards for grounding, shielding, and safety.

WARNING:

Terminals on this unit may be connected to hazardous voltages. Before making ANY connections to this unit, always remove power from the loop or instrument power terminals.

Contact/Load Suppression

When the instrument relays are used to switch an inductive load such as an external relay coil, contactor, solenoid, large voltage spikes may be created in nearby cable harnesses. When excessive, these voltage spikes can disrupt the operation of all nearby electronics including this product. Inductive loads should have suppression devices installed at the load (for external relays this would be right across the relay coil itself). Usually this is a simple diode for dc circuits. AC circuits routinely use an R-C snubber. Please follow the external load manufacturer instructions for their recommended suppression kits.

Recommended Ground Wiring Practices

Moore Industries recommends the following ground wiring practices:

- Any Moore Industries product in a metal case or housing should be grounded.
- The protective earth conductor must be connected to a system safety earth ground before making other connections.
- All input signals to, and output signals from, Moore Industries' products should be wired using a shielded, twisted pair wiring technique. Shields should be connected to an earth or safety ground.
- For the best shielding, the shield should be run all the way from the signal source to the receiving device. (see Note)
- The maximum length of unshielded input and output signal wiring should be 2 inches.

Note:

Some of Moore Industries' instruments can be classified as receivers (IPT, IPX, etc.) and some can be classified as transmitters (TRX, TRY, etc.) while some are both a receiver and a transmitter (SPA, HIM, etc). Hence, your shield ground connections should be appropriate for the type of signal line being shielded. The shield should be grounded at the signal source and not at the receiver.

Supply Wiring

All power connections should be made with the proper wire.

The end of each conductor should be stripped no more than 8mm (0.31 in). The end of the stripped wire should be tinned with solder, or inserted into a ferrule and crimped before being placed into a terminal block.

Conductors connected to screw-type connections should have a ring-lug or spade-lug crimped onto the wire end.

Tighten the screws on the terminal block to 4.4 - 5.3 lbf•in (0.5 - 0.6 N•m).

CE Conformity

Installation of any Moore Industries' products that carry the CE marking **must** adhere to the guidelines in the *Recommended Ground Wiring Practices* section in order to meet the EN 61326 requirements set forth in the applicable EMC directive.

Operation

Once programmed, calibrated, installed and supplied with the correct power, the TCM and HMC begin to operate immediately. Depending upon environmental conditions, they can be expected to operate unattended for extended periods of time.

HART Protocol

This section of the manual gives an overview of the HART format used by TCM module during operation. Use the information in this section to process the data provided by the module(s) during operation. For more information on the HART protocol, contact the HART Foundation at:

HART Communication Foundation
9390 Research Blvd., Suite I-350
Austin, TX 78759-6540
USA
Phone: (512) 794-0369
Fax: (512) 794-3904
www.hartcomm.org

Maintenance

Moore Industries suggests a quick check for terminal tightness and general unit condition every 6-8 months. Always adhere to any site requirements for programmed maintenance.

Customer Support

If service assistance is ever required for an device in your application, refer to the back cover of this manual for the telephone numbers to Moore Industries' customer service department.

If possible, make a note of the model number of the unit before calling. For fastest assistance, have the following information available: serial number, the job number and purchase order number under which it was shipped

TCS

Temperature Concentrator System™
Multi-Channel Transmitter

Installation in Hazardous Locations

This section contains important information regarding installation of the TCM in Hazardous Area Locations.



WARNING:

Do not separate power connector when energized.



WARNING:

Substitution of components is not allowed, as it may impair the intrinsic safety.



AVERTISSEMENT:

La substitution de composants peut compromettre la sécurité intrinsèque.



WARNING:

To prevent ignition of flammable or combustible atmospheres, disconnect power before servicing.



AVERTISSEMENT:

Risque d'explosion. Avant de déconnecter l'équipement, couper le courant ou s'assurer que débrancher tant que l'emplacement est désigné non dangereux.



WARNING:

Explosion Hazard. Do not disconnect equipment when a flammable or combustible atmosphere is present.



AVERTISSEMENT:

Risque d'explosion. Ne pas débrancher tant que le circuit est sous tension, à moins qu'il ne s'agisse d'un emplacement non dangereux.

The Figure 23 (next page) must be used for units that are to operate in areas requiring intrinsically-safe instrumentation. Refer to the *Specific Conditions* outlined below before proceeding with installation.

Specific Conditions of Use

The following instructions must be adhered to when the TCM is used in hazardous 'Classified' locations and potentially explosive atmospheres.

cFMus Installations

I. Intrinsically Safe Applications

Ex ia Zones 0 & 1, Class I, Division 1, Groups A-D

1. The Model TCM Temperature Concentrator Module shall be installed in an enclosure which maintains an ingress protection rating of IP20.
2. The Model TCM Temperature Concentrator Module shall be installed in final enclosure which meets the requirements of ANSI/ISA 61010-1 and the National Electrical Code®.
3. For Zone 0 and Division 1 installations, the final enclosure shall not contain more than 10% in total of aluminum, magnesium, titanium and zirconium, or 7.5% in total of magnesium, titanium and zirconium. For Zone 1 installations, the final enclosure shall not contain 7.5% in total magnesium.
4. If the final enclosure is non-metallic, under certain extreme circumstances, the non-metallic parts incorporated in the final enclosure of this equipment may generate an ignition-capable level of electrostatic charge. Therefore particularly when it is used for applications that specifically require group II, Zone 0 and Division 1 located equipment, that the equipment shall not be installed in a location where the external conditions are conducive to the build-up of electrostatic charge on such surfaces. Additionally, the equipment shall only be cleaned with a damp cloth.
5. The COM port shall not be used in the hazardous area.
6. The Model TCM Temperature Concentrator Module shall be installed in a final enclosure which meets the requirements of C22.2. No. 1010-1 and the Canadian Electrical Code.

Figure 23. TCS System Hook-Up Using an Intrinsically-Safe Barrier. See Appendices for specific hook-up diagrams to recommended I.S. barriers

WARNING:

In an intrinsically-safe system, COM ports cannot be used unless the hazard is completely removed. Therefore, it is suggested that configuration of the TCM and HMC be performed before their placement into a TCS system. This removes the need for use of COM ports in the hazardous area.

Externally-Powered System

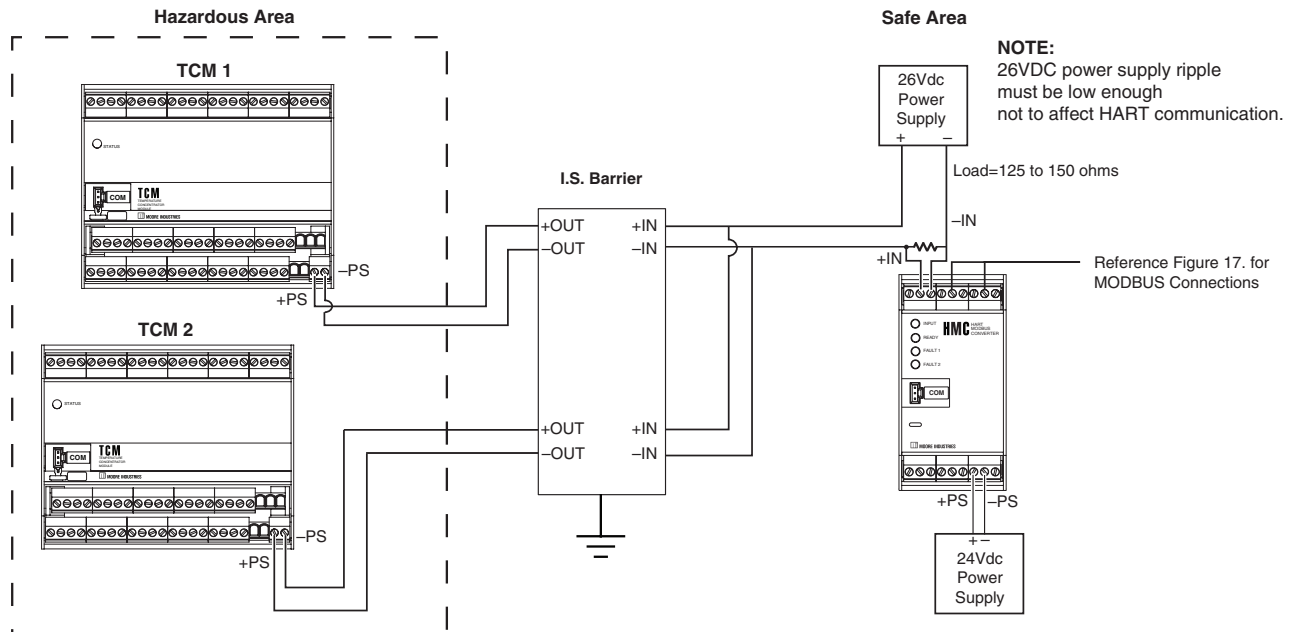

TCS

Temperature Concentrator System™
Multi-Channel Transmitter

II. Non-Incendive Applications, Zone 2, Class I & II, Division 2, Class III, Division 1 & 2, Groups A-D

1. The Model TCM Temperature Concentrator Module shall be installed in a final enclosure which meets the requirements of ANSI/ISA 61010-1 and the National Electrical Code® or meets the requirements of C22.2 No. 1010-1 and the Canadian Electrical Code.
2. The COM port shall not be used in the hazardous area.

European Union Installations (ATEX 2014/30/EU Directive)

I. Intrinsically Safe Applications II 1 G Ex ia IIC, Zones 0, 1 or 2

1. The Model TCM Temperature Concentrator Module shall be installed in an enclosure which maintains an ingress protection rating of IP20.
2. For Zone 0, the final enclosure shall not contain more than 10% in total of aluminum, magnesium, titanium and zirconium; or 7.5% in total of magnesium, titanium and zirconium. For Zone 1 installations, the final enclosure shall not contain 7.5% in total of magnesium.
3. If the final enclosure is non-metallic, under certain extreme circumstances, the non-metallic parts incorporated in the final enclosure of this equipment may generate an ignition-capable level of electrostatic charge. Therefore particularly when it is used for applications that specifically require Group II, Zone 0 located equipment, that the equipment shall not be installed in a location where the external conditions are conducive to the build-up of electrostatic charge on such surfaces. Additionally, the equipment shall only be cleaned with a damp cloth.
4. Using the box provided on the nameplate, the User shall permanently mark the protection type chosen for the specific installation. Once the type of protection has been marked it shall not be changed.
5. The COM port shall not be used in the hazardous area.

II. Type “n” Applications II 3 G Ex nA IIC, Zone 2

1. If the Model TCM Temperature Concentrator Module is installed as Category 3 equipment, it shall be installed in an enclosure which maintains an ingress protection rating of IP54 and meets the enclosure requirements of EN60079-0 and EN60079-15.
2. If the final enclosure is non-metallic, under certain extreme circumstances, the non-metallic parts incorporated in the final enclosure of this equipment may generate an ignition-capable level of electrostatic charge. Therefore particularly when it is used for applications that specifically require Group II, Zone 0 located equipment, that the equipment shall not be installed in a location where the external conditions are conducive to the build-up of electrostatic charge on such surfaces. Additionally, the equipment shall only be cleaned with a damp cloth.
3. The Model TCM Temperature Concentrator Module shall contain external transient protection to prevent the supply voltage from exceeding 46.2V including tolerance.
4. Using the box provided on the nameplate, the User shall permanently mark the protection type chosen for the specific installation. Once the type of protection has been marked it shall not be changed.
5. The COM port shall not be used in the hazardous area.

IECEx Installations

I. Intrinsically Safe Applications

Ex ia IIC, Zones 0, 1 or 2

1. The Model TCM Temperature Concentrator Module shall be installed in an enclosure which maintains an ingress protection rating of IP20.
2. For Zone 0, the final enclosure shall not contain more than 10% in total of aluminum, magnesium, titanium and zirconium; or 7.5% in total of magnesium, titanium and zirconium. For Zone 1 installations, the final enclosure shall not contain 7.5% in total of magnesium.
3. If the final enclosure is non-metallic, under certain extreme circumstances, the non-metallic parts incorporated in the final enclosure of this equipment may generate an ignition-capable level of electrostatic charge. Therefore particularly when it is used for applications that specifically require Group II, Zone 0 located equipment, that the equipment shall not be installed in a location where the external conditions are conducive to the build-up of electrostatic charge on such surfaces. Additionally, the equipment shall only be cleaned with a damp cloth.
4. Using the box provided on the nameplate, the User shall permanently mark the protection type chosen for the specific installation. Once the type of protection has been marked it shall not be changed.
5. The COM port shall not be used in the hazardous area.

Type “n” Applications

Ex nA [nL] IIC, Zone 2

1. If the Model TCM Temperature Concentrator Module is installed as Category 3 equipment, it shall be installed in an enclosure which maintains an ingress protection rating of IP54 and meets the enclosure requirements of EN60079-0 and EN60079-15.
2. If the final enclosure is non-metallic, under certain extreme circumstances, the non-metallic parts incorporated in the final enclosure of this equipment may generate an ignition-capable level of electrostatic charge. Therefore particularly when it is used for applications that specifically require Group II, Zone 0 located equipment, that the equipment shall not be installed in a location where the external conditions are conducive to the build-up of electrostatic charge on such surfaces. Additionally, the equipment shall only be cleaned with a damp cloth.
3. The Model TCM Temperature Concentrator Module shall contain external transient protection to prevent the supply voltage from exceeding 46.2V including tolerance.
4. Using the box provided on the nameplate, the User shall permanently mark the protection type chosen for the specific installation. Once the type of protection has been marked it shall not be changed.
5. The COM port shall not be used in the hazardous area.

Refer to the Safety Concerns section on the previous page before continuing with installation.

TCS

Temperature Concentrator System™
Multi-Channel Transmitter

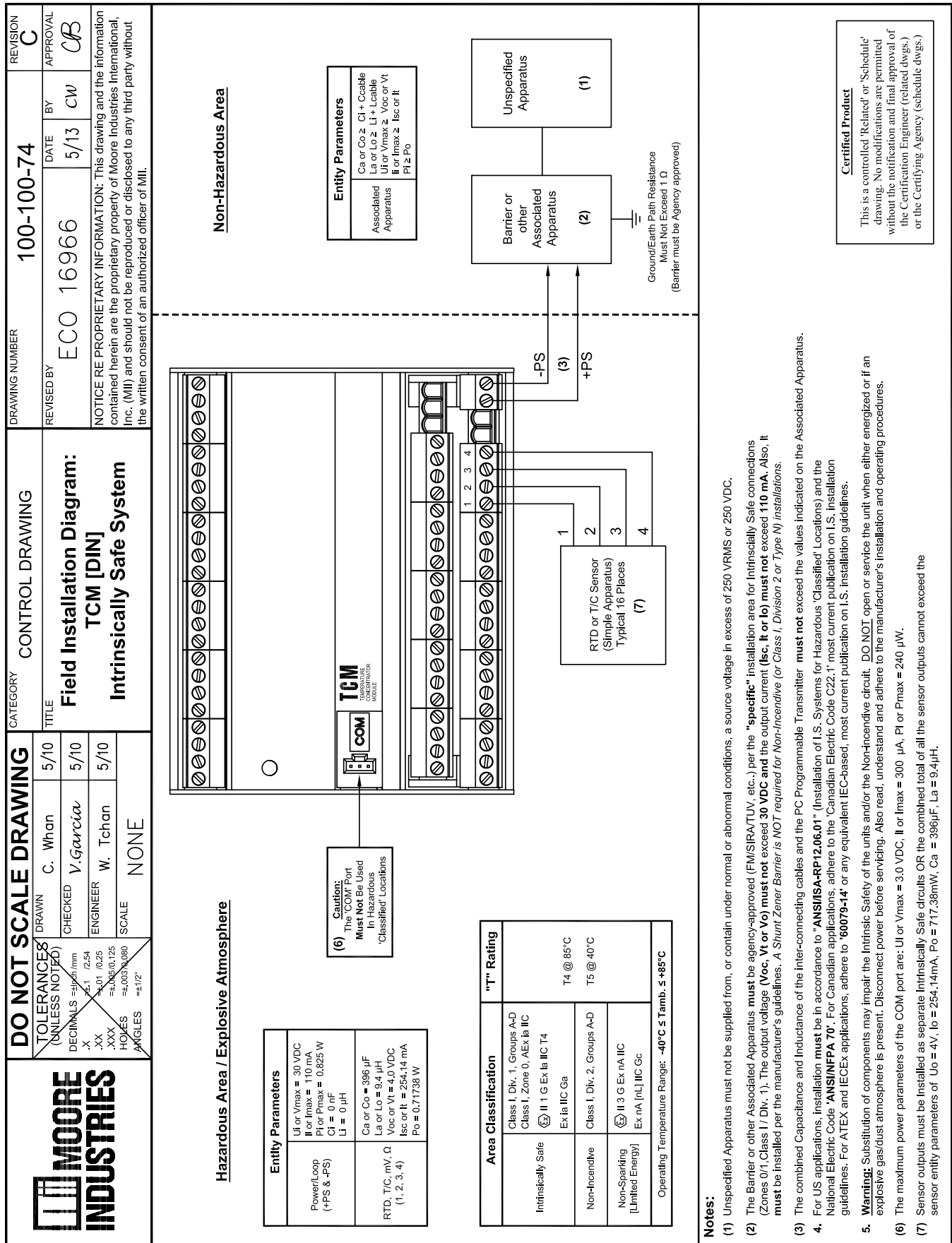

DO NOT SCALE DRAWING		CATEGORY COMPUTERIZED LABEL		DRAWING NUMBER 200-251-2342		REVISION C4	
TOLERANCES (UNLESS NOTED)		DRAWN C. Whorn		TITLE ID LABEL, TCM [DIN] -CFMUS/IECEX/ATEX CERTIFICATION		REVISED BY ECO 19021	
DECIMALS ±.01 / .254		CHECKED V. Garcia		DATE 11/20		BY VG	
XXX ±.005 / .125		ENGINEER W. Tchon		APPROVAL		WT	
HOLES ±.003 / 0.080		SCALE 1/1		NOTICE RE PROPRIETARY INFORMATION: This drawing and the information contained herein are the proprietary property of Moore Industries International, Inc. (MII) and should not be reproduced or disclosed to any third party without the written consent of an authorized officer of MII.			
ANGLES ±.1°							

Certified Product

This is a controlled 'Related' or 'Schedule' drawing. No modifications are permitted without the notification and final approval of the Certification Engineer (related dwgs.) or the Certifying Agency (schedule dwgs.)

- NOTES: UNLESS OTHERWISE SPECIFIED**
1. MATERIAL: .002 SILVER, IDENTIPATE (MIL P/N 200-305-00) CUT TO SIZE AS SHOWN. REFER TO LABEL SPEC. DRAWING 200-305-00. ADHESIVE BACKING IS UL/CSA APPROVED HIGH PERFORMANCE ACRYLIC. PRINTING IS WITH BLACK, UL/CSA, THERMAL TRANSFER RIBBON (801-003-96).
 2. THE FIXED TEXT AND GRAPHIC FIELDS FOR THIS LABEL ARE STORED UNDER NO. 200-251-2342 IN THE LEGI 93 LABEL MACHINE COMPUTER HARD DISK.
 3. TO PRINT THIS LABEL: JOB SPECIFIC MODEL, SERIAL, AND TAG NUMBERS WILL BE DOWNLOADED FROM THE MENTOR DATA FILE AND PRINTED ALONG WITH THE FIXED TEXT AND GRAPHICS (SUPPLIED BY THE LEGI 93 DATA FILE) TO CREATE THE FINISHED LABEL.
 4. ALL MATERIAL MUST BE ROHS COMPLIANT.

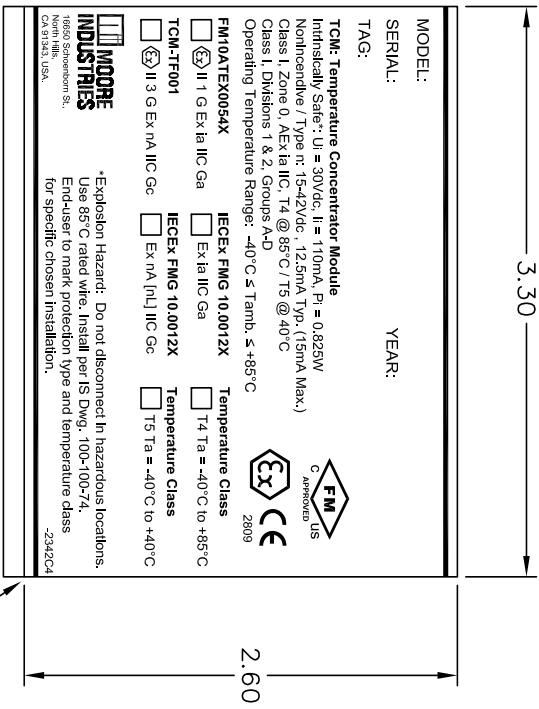

TCS

Temperature Concentrator System™
Multi-Channel Transmitter

Appendix A: TCS/Stahl I.S. Barrier Configuration

To use the TCS Temperature Concentrator System in an intrinsically-safe Class I, II, III, Division 1 (Zone 0) hazardous area, an I.S. Barrier such as STAHL Type 9160/13-11-11s (single-channel) or STAHL Type 9160/23-11-11s (dual-channel) can be used as illustrated below.

Figure 24. TCS/Stahl Configuration Hook-Up

Single-Channel

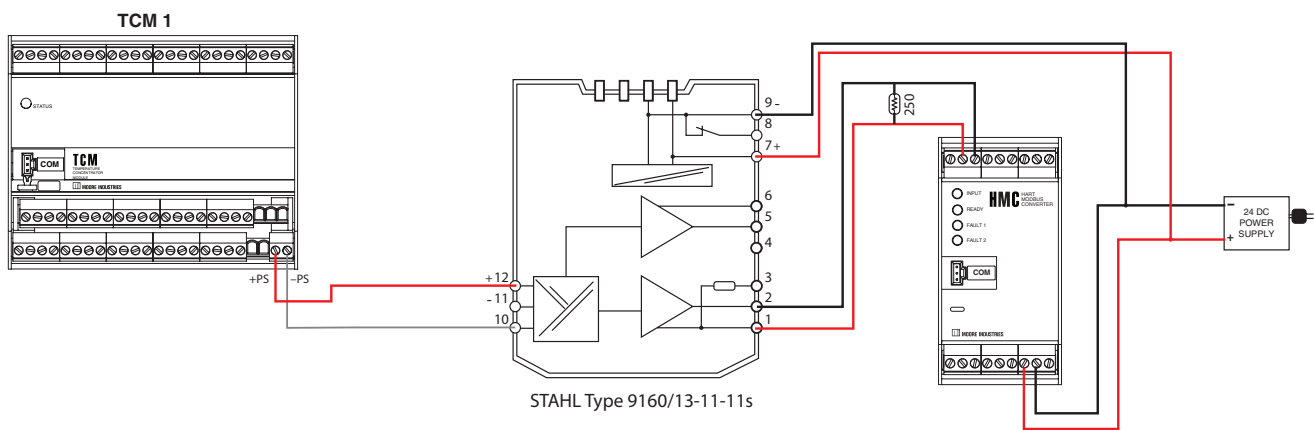

Dual-Channel

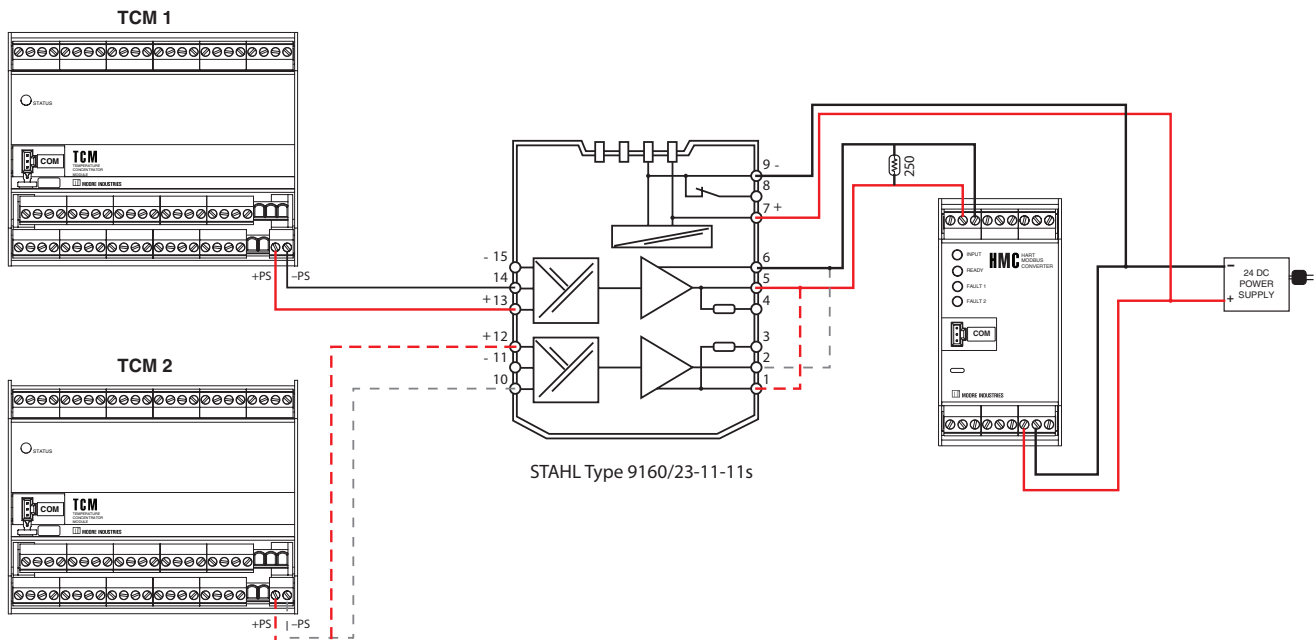

Appendix B: TCS/GMI I.S. Barrier Configuration

To use the TCS Temperature Concentrator System in an intrinsically-safe Class I, II, III, Division 1 (Zone 0) hazardous area, an I.S. Barrier such as GMI D1010S (single-channel) or GMI D1010D (dual-channel) can be used as illustrated below.

Figure 25. TCS/GMI Configuration Hook-Up

Single-Channel

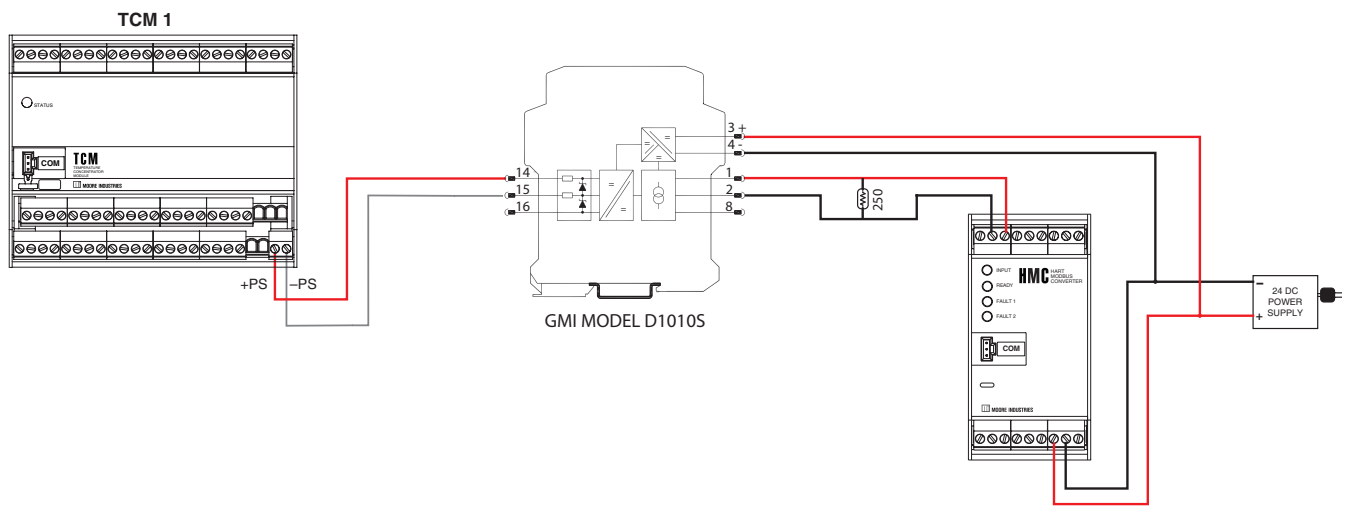

Dual-Channel

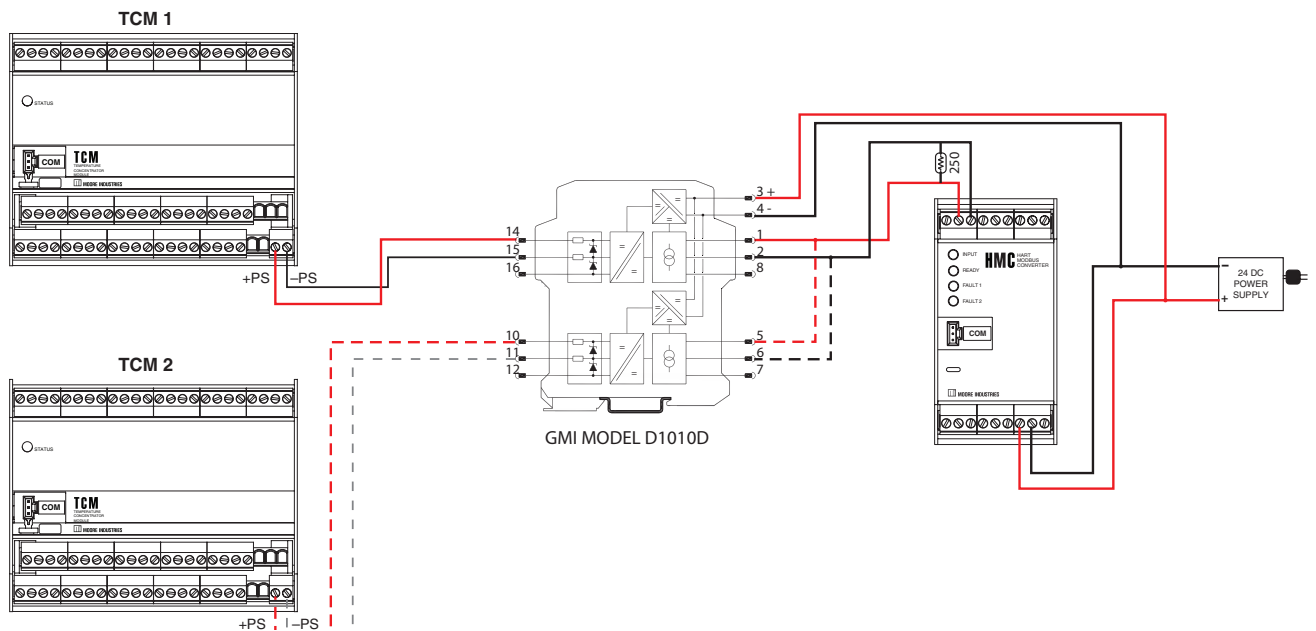

RETURN PROCEDURES

To return equipment to Moore Industries for repair, follow these four steps:

1. Call Moore Industries and request a Returned Material Authorization (RMA) number.

Warranty Repair –

If you are unsure if your unit is still under warranty, we can use the unit's serial number to verify the warranty status for you over the phone. Be sure to include the RMA number on all documentation.

Non-Warranty Repair –

If your unit is out of warranty, be prepared to give us a Purchase Order number when you call. In most cases, we will be able to quote you the repair costs at that time. The repair price you are quoted will be a "Not To Exceed" price, which means that the actual repair costs may be less than the quote. Be sure to include the RMA number on all documentation.

2. Provide us with the following documentation:
 - a) A note listing the symptoms that indicate the unit needs repair
 - b) Complete shipping information for return of the equipment after repair
 - c) The name and phone number of the person to contact if questions arise at the factory
3. Use sufficient packing material and carefully pack the equipment in a sturdy shipping container.
4. Ship the equipment to the Moore Industries location nearest you.

The returned equipment will be inspected and tested at the factory. A Moore Industries representative will contact the person designated on your documentation if more information is needed. The repaired equipment, or its replacement, will be returned to you in accordance with the shipping instructions furnished in your documentation.

WARRANTY DISCLAIMER

THE COMPANY MAKES NO EXPRESS, IMPLIED OR STATUTORY WARRANTIES (INCLUDING ANY WARRANTY OF MERCHANTABILITY OR OF FITNESS FOR A PARTICULAR PURPOSE) WITH RESPECT TO ANY GOODS OR SERVICES SOLD BY THE COMPANY. THE COMPANY DISCLAIMS ALL WARRANTIES ARISING FROM ANY COURSE OF DEALING OR TRADE USAGE, AND ANY BUYER OF GOODS OR SERVICES FROM THE COMPANY ACKNOWLEDGES THAT THERE ARE NO WARRANTIES IMPLIED BY CUSTOM OR USAGE IN THE TRADE OF THE BUYER AND OF THE COMPANY, AND THAT ANY PRIOR DEALINGS OF THE BUYER WITH THE COMPANY DO NOT IMPLY THAT THE COMPANY WARRANTS THE GOODS OR SERVICES IN ANY WAY.

ANY BUYER OF GOODS OR SERVICES FROM THE COMPANY AGREES WITH THE COMPANY THAT THE SOLE AND EXCLUSIVE REMEDIES FOR BREACH OF ANY WARRANTY CONCERNING THE GOODS OR SERVICES SHALL BE FOR THE COMPANY, AT ITS OPTION, TO REPAIR OR REPLACE THE GOODS OR SERVICES OR REFUND THE PURCHASE PRICE. THE COMPANY SHALL IN NO EVENT BE LIABLE FOR ANY CONSEQUENTIAL OR INCIDENTAL DAMAGES EVEN IF THE COMPANY FAILS IN ANY ATTEMPT TO REMEDY DEFECTS IN THE GOODS OR SERVICES, BUT IN SUCH CASE THE BUYER SHALL BE ENTITLED TO NO MORE THAN A REFUND OF ALL MONIES PAID TO THE COMPANY BY THE BUYER FOR PURCHASE OF THE GOODS OR SERVICES.

ANY CAUSE OF ACTION FOR BREACH OF ANY WARRANTY BY THE COMPANY SHALL BE BARRED UNLESS THE COMPANY RECEIVES FROM THE BUYER A WRITTEN NOTICE OF THE ALLEGED DEFECT OR BREACH WITHIN TEN DAYS FROM THE EARLIEST DATE ON WHICH THE BUYER COULD REASONABLY HAVE DISCOVERED THE ALLEGED DEFECT OR BREACH, AND NO ACTION FOR THE BREACH OF ANY WARRANTY SHALL BE COMMENCED BY THE BUYER ANY LATER THAN TWELVE MONTHS FROM THE EARLIEST DATE ON WHICH THE BUYER COULD REASONABLY HAVE DISCOVERED THE ALLEGED DEFECT OR BREACH.

RETURN POLICY

For a period of thirty-six (36) months from the date of shipment, and under normal conditions of use and service, Moore Industries ("The Company") will at its option replace, repair or refund the purchase price for any of its manufactured products found, upon return to the Company (transportation charges prepaid and otherwise in accordance with the return procedures established by The Company), to be defective in material or workmanship. This policy extends to the original Buyer only and not to Buyer's customers or the users of Buyer's products, unless Buyer is an engineering contractor in which case the policy shall extend to Buyer's immediate customer only. This policy shall not apply if the product has been subject to alteration, misuse, accident, neglect or improper application, installation, or operation. THE COMPANY SHALL IN NO EVENT BE LIABLE FOR ANY INCIDENTAL OR CONSEQUENTIAL DAMAGES.



United States • info@miinet.com
Tel: (818) 894-7111 • FAX: (818) 891-2816
Australia • sales@mooreind.com.au
Tel: (02) 8536-7200 • FAX: (02) 9525-7296

Demand Moore Reliability

www.miinet.com

BeNeLux • info@mooreind.eu
Tel: 03/448.10.18 • FAX: 03/440.17.97

China • sales@mooreind.sh.cn
Tel: 86-21-62491499 • FAX: 86-21-62490635
United Kingdom • sales@mooreind.com
Tel: 01293 514488 • FAX: 01293 536852